

Solenoids for solenoid valves - Mod. A80

Product code: A83

Datasheet creation date: 19/05/2026 08:45

Check the most updated document online [click here](#)



TECHNICAL DATA

Mod.	A83
Voltage (V)	24
Frequency (Hz)	D.C.
Power absorption	4 W

Solenoids for solenoid valves - Mod. A80

Product code: A83

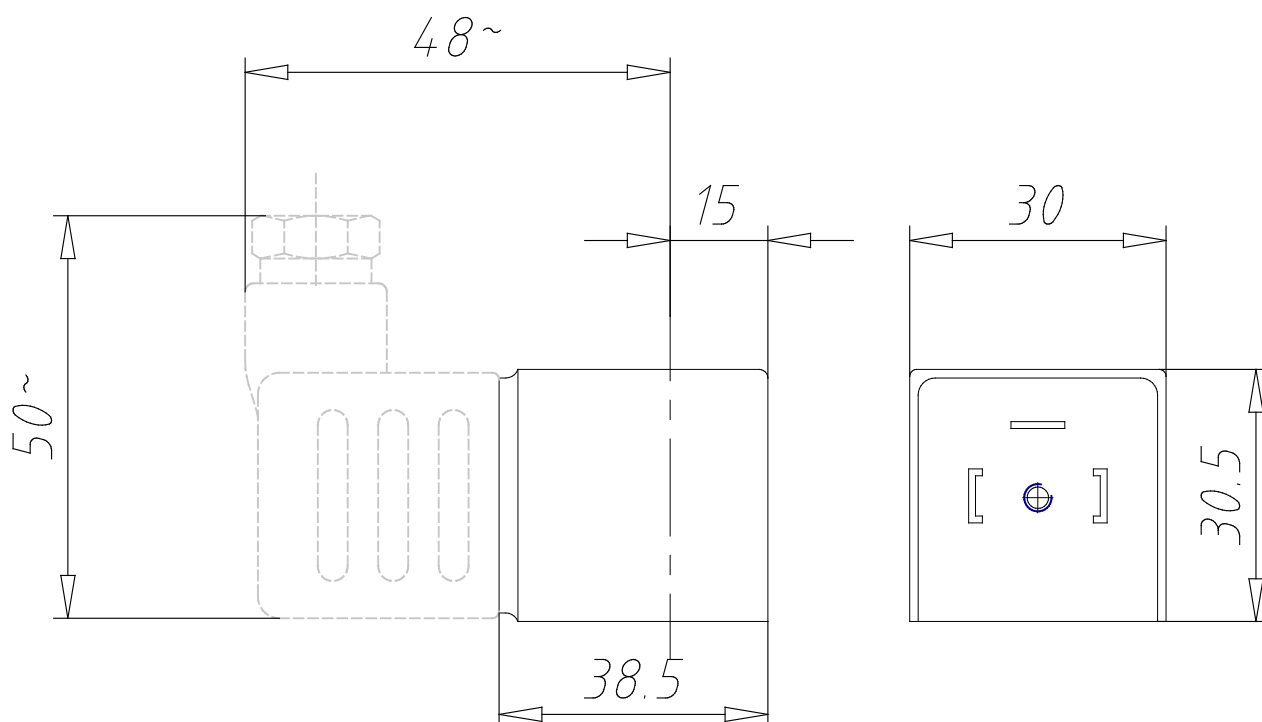

DIMENSIONS

Mod.	A83
Voltage (V)	24
Frequency (Hz)	D.C.
Power absorption	4 W