

## 2/2 and 3/2-way solenoid valves - Mod. A331

Product code: A321-0C2

Datasheet creation date: 19/05/2026 16:53

Check the most updated document online [click here](#)



### TECHNICAL DATA

Mod.	A321-0C2
------	----------

## 2/2 and 3/2-way solenoid valves - Mod. A331

Product code: A321-0C2

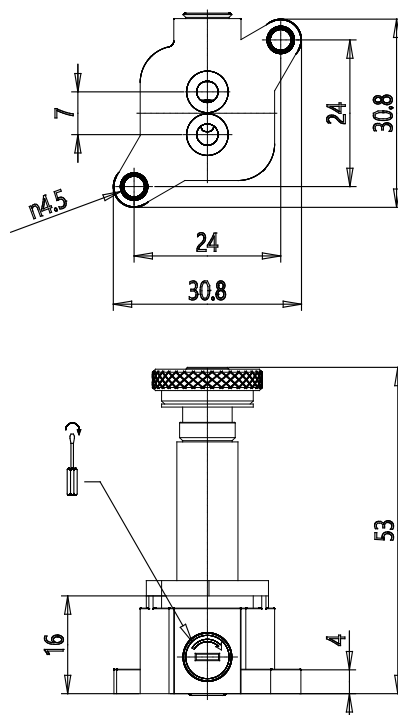

### **DIMENSIONS**