

## 5/2-way solenoid valves, ISO 1, ISO 2, ISO 3, monostable - Series 9

Product code: 953-000-P15-23

Datasheet creation date: 19/05/2026 08:47

Check the most updated document online [click here](#)

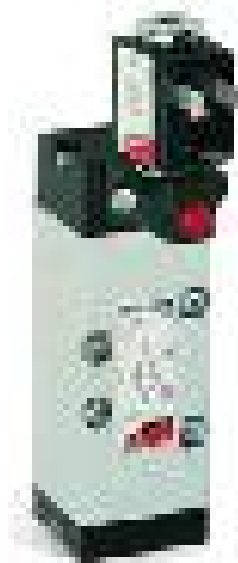

### TECHNICAL DATA

Mod.	953-000-P15-23
------	----------------

## 5/2-way solenoid valves, ISO 1, ISO 2, ISO 3, monostable - Series 9

Product code: 953-000-P15-23

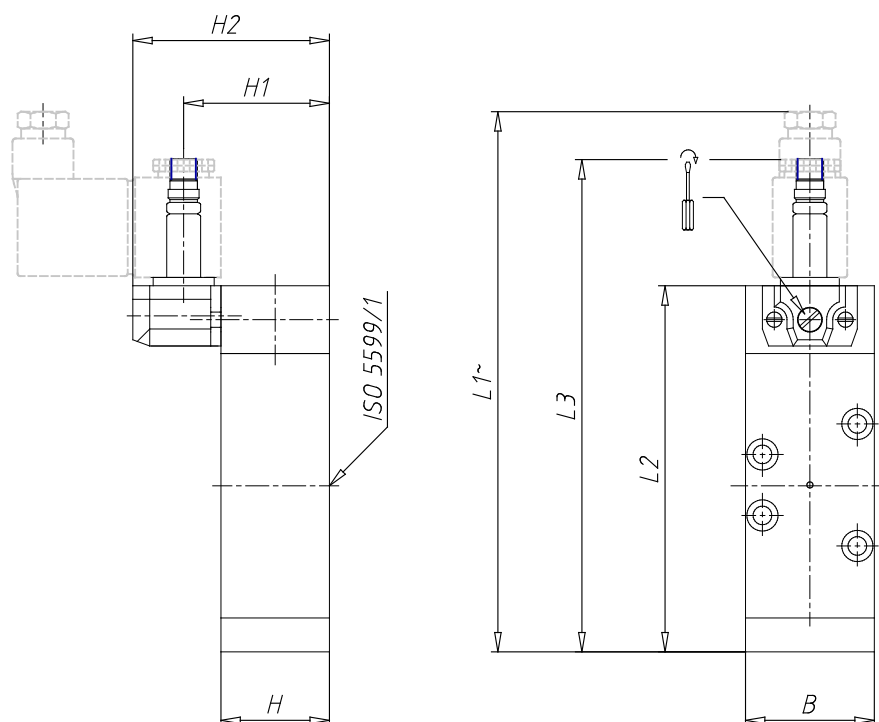

### DIMENSIONS

Size ISO	3
B (mm)	65
L1 (mm)	218
L2 (mm)	173
L3 (mm)	211
H (mm)	45
H1 (mm)	56.5
H2 (mm)	72