

5/2-way solenoid valves, ISO 1, ISO 2, ISO 3, monostable - Series 9

Product code: 951-000-P16-23

Datasheet creation date: 19/05/2026 08:48

Check the most updated document online [click here](#)

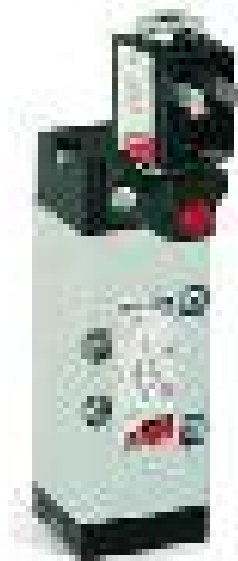

■ TECHNICAL DATA

Mod.	951-000-P16-23
------	----------------

5/2-way solenoid valves, ISO 1, ISO 2, ISO 3, monostable - Series 9

Product code: 951-000-P16-23

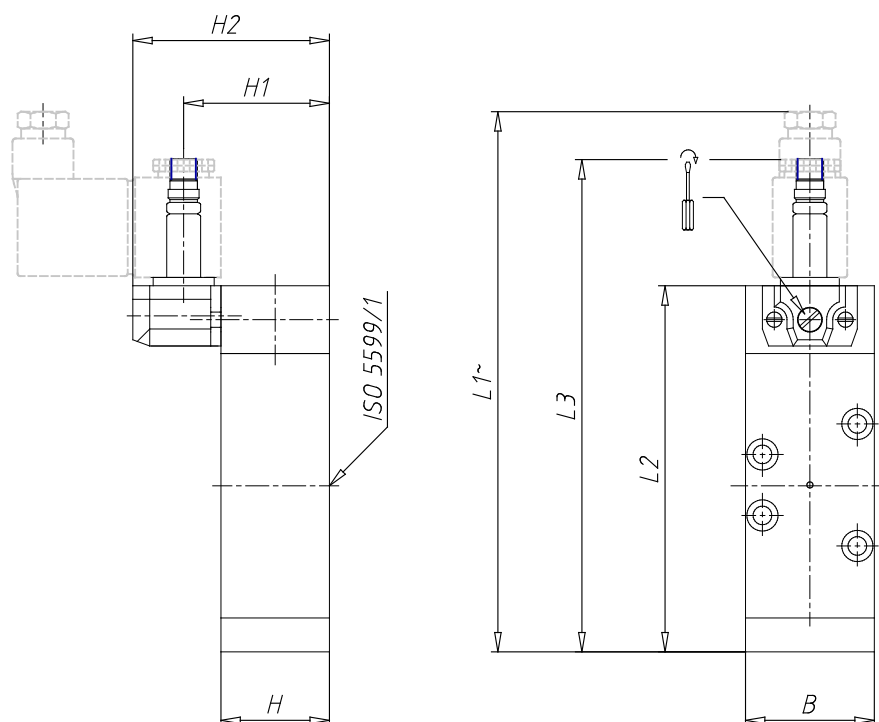

DIMENSIONS

Size ISO	1
B (mm)	38
L1 (mm)	153
L2 (mm)	108
L3 (mm)	146
H (mm)	32
H1 (mm)	43.5
H2 (mm)	59