

End block with front outlets (VDMA 24345) - Series 9

Product code: 903-N3

Datasheet creation date: 20/05/2026 01:54

Check the most updated document online [click here](#)



TECHNICAL DATA

Mod.	903-N3
Size	3

End block with front outlets (VDMA 24345) - Series 9

Product code: 903-N3

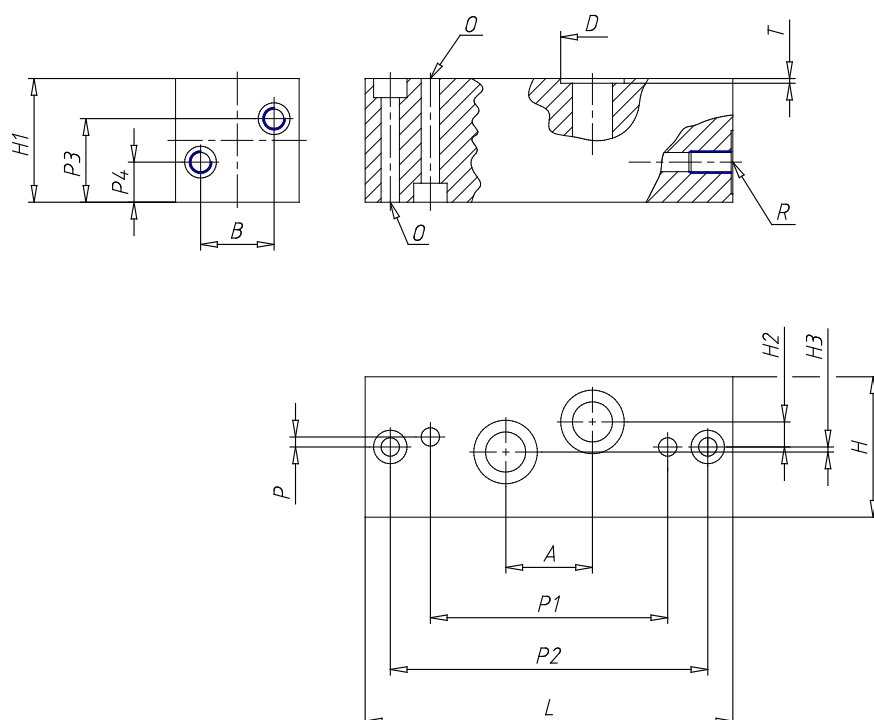

DIMENSIONS

A (mm)	38
B (mm)	36
D (mm)	27
H (mm)	70
H1 (mm)	45
H2 (mm)	8.0
H3 (mm)	6.0
L (mm)	190
O (mm)	9.0
P (mm)	3
P1 (mm)	130
P2 (mm)	168
P3 (mm)	29
P4 (mm)	17
R	G1/2
T (mm)	1.4