

End block with front outlets (VDMA 24345) - Series 9

Product code: 902-N2

Datasheet creation date: 20/05/2026 01:55

Check the most updated document online [click here](#)



TECHNICAL DATA

Mod.	902-N2
Size	2

End block with front outlets (VDMA 24345) - Series 9

Product code: 902-N2

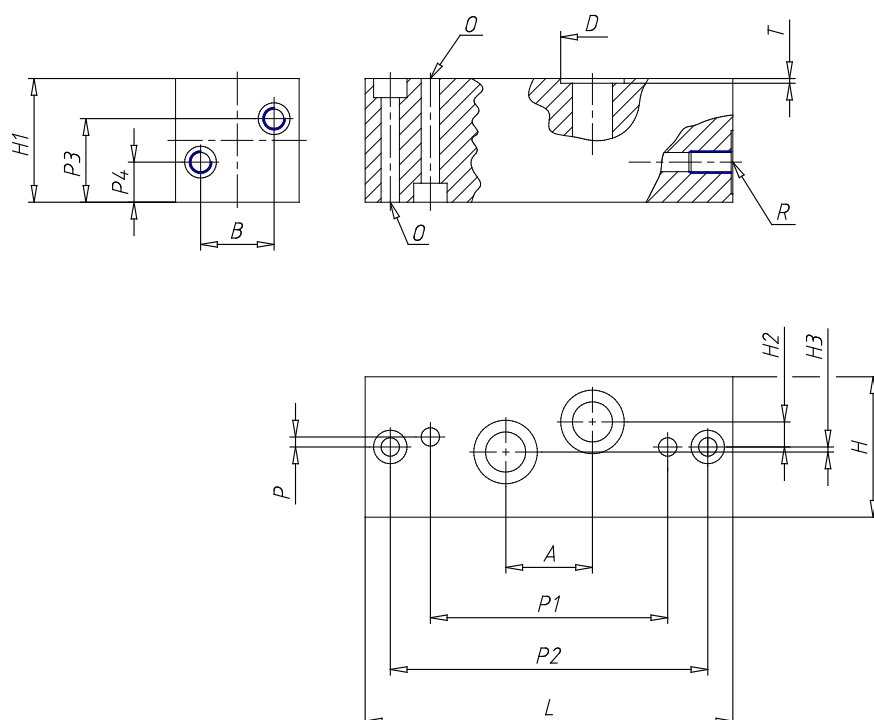

DIMENSIONS

A (mm)	30
B (mm)	29
D (mm)	23
H (mm)	55
H1 (mm)	40
H2 (mm)	6.0
H3 (mm)	5.0
L (mm)	135
O (mm)	6.5
P (mm)	3
P1 (mm)	86
P2 (mm)	115
P3 (mm)	26
P4 (mm)	14
R	G3/8
T (mm)	1.4