

End block for manifold sub-base (VDMA 24345) - Series 9

Product code: 902-H2

Datasheet creation date: 19/05/2026 08:31

Check the most updated document online [click here](#)



TECHNICAL DATA

Mod.	902-H2
Size	2

End block for manifold sub-base (VDMA 24345) - Series 9

Product code: 902-H2

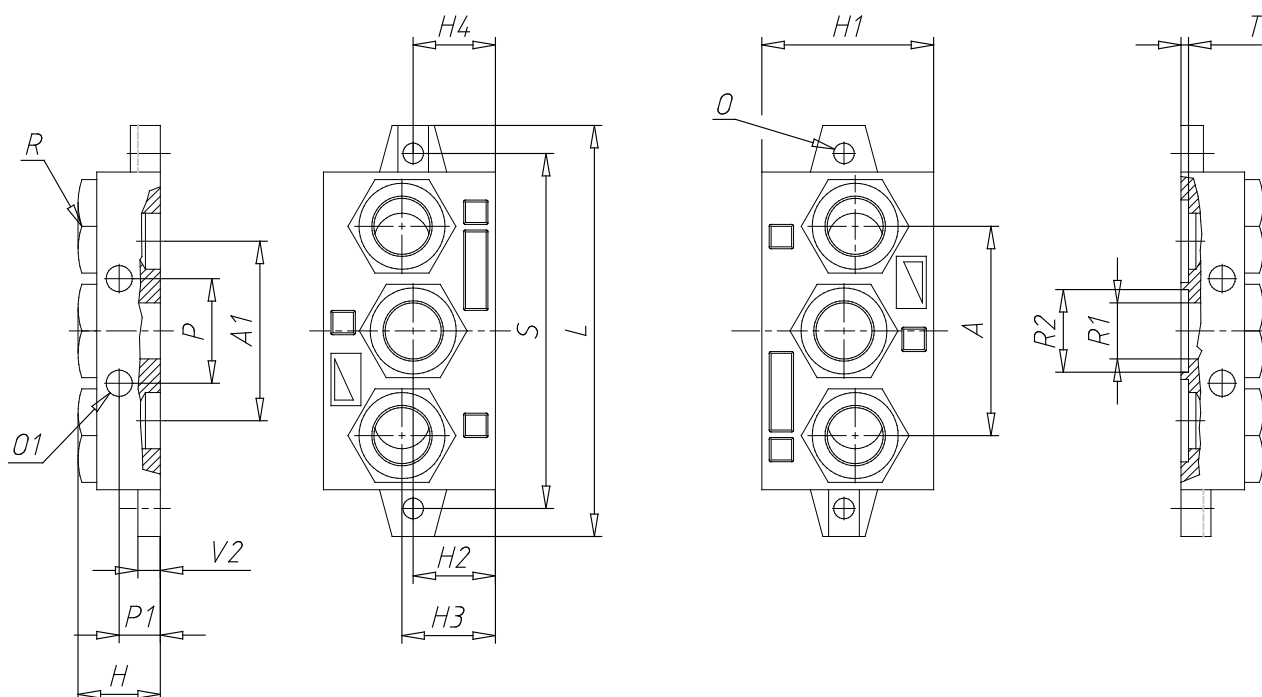

DIMENSIONS

A (mm)	68
A1 (mm)	63
H (mm)	26
H1 (mm)	47
H2 (mm)	23
H3 (mm)	25
H4 (mm)	24
L (mm)	135
O (mm)	6.5
O1 (mm)	9
P (mm)	35
P1 (mm)	13
R	G1/2
ØR1	18.5
ØR2	28.7
S (mm)	115
T (mm)	2.0
V2 (mm)	8