

Mod. 7632 03 - Fittings Series 7000 - Automation

Product code: 7632 03-1/8

Datasheet creation date: 19/05/2026 18:09

Check the most updated document online [click here](#)



■ TECHNICAL DATA

Mod.	7632 03-1/8
------	-------------

Mod. 7632 03 - Fittings Series 7000 - Automation

Product code: 7632 03-1/8

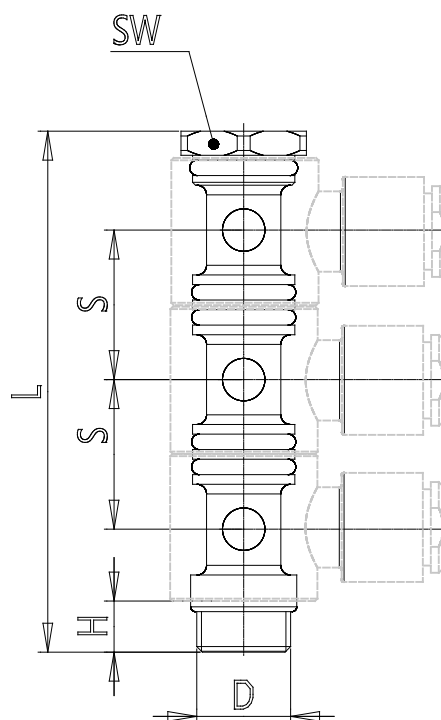

DIMENSIONS

D	G1/8
E (mm)	7.8
L (mm)	54.0
N (mm)	21.5
S (mm)	15.5
O (mm)	15.5
V (mm)	11.0
SW (mm)	13
Weight (g)	17