

Mod. 7540 - Compact fittings Serie 7000

Product code: 7540 10

Datasheet creation date: 19/05/2026 18:07

Check the most updated document online [click here](#)



TECHNICAL DATA

Mod.	7540 10
------	---------

Mod. 7540 - Compact fittings Serie 7000

Product code: 7540 10

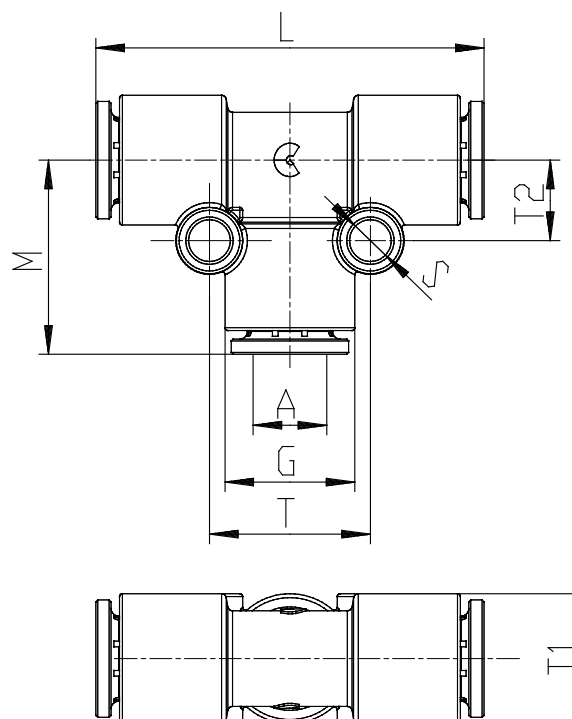

DIMENSIONS

A (mm)	10
G (mm)	16.1
L (mm)	48
M (mm)	24.0
S (mm)	4
T (mm)	16.0
T1 (mm)	15.8
T2 (mm)	8.0