

Mod. 6590 - Series 6000 fittings

Product code: 6590 6

Datasheet creation date: 19/05/2026 08:53

Check the most updated document online [click here](#)



TECHNICAL DATA

Mod.	6590 6
------	--------

Mod. 6590 - Series 6000 fittings

Product code: 6590 6

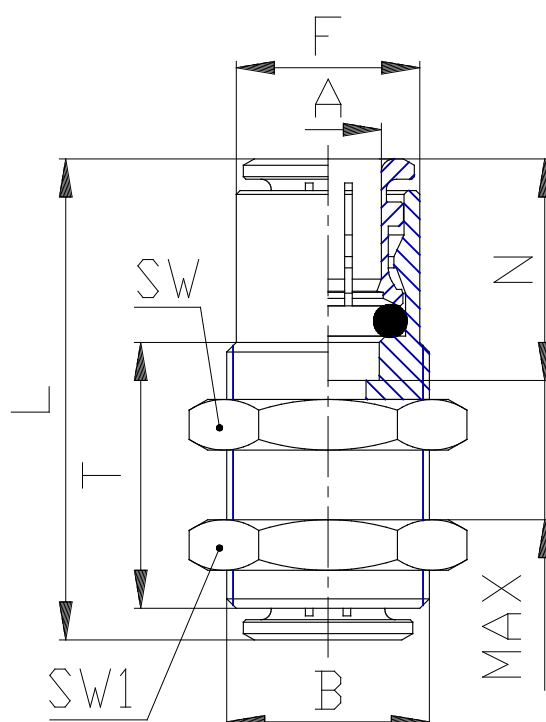

DIMENSIONS

A (mm)	6
B	M14x1
F (mm)	12.5
L (mm)	33.0
N (mm)	16.0
SW (mm)	17
SW1 (mm)	17
T (mm)	20.0