

Mod. 6590 - Series 6000 fittings

Product code: 6590 10

Datasheet creation date: 19/05/2026 18:20

Check the most updated document online [click here](#)



TECHNICAL DATA

Mod.	6590 10
------	---------

Mod. 6590 - Series 6000 fittings

Product code: 6590 10

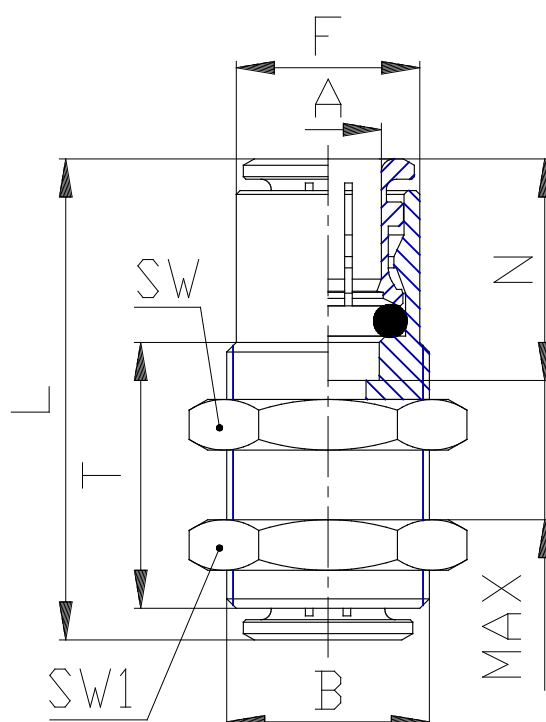

DIMENSIONS

A (mm)	10
B	M18x1
F (mm)	16.3
L (mm)	41.5
N (mm)	20.2
SW (mm)	22
SW1 (mm)	22
T (mm)	23.5