

Mod. 6580 union - Series 6000 fittings

Product code: 6580 10

Datasheet creation date: 19/05/2026 08:53

Check the most updated document online [click here](#)



■ TECHNICAL DATA

Mod.	6580 10
------	---------

Mod. 6580 union - Series 6000 fittings

Product code: 6580 10

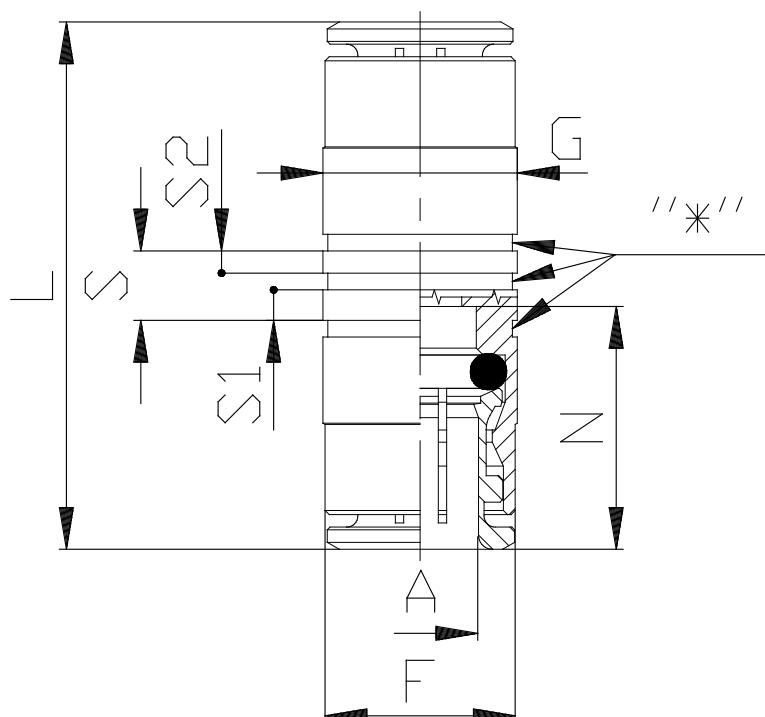

DIMENSIONS

A (mm)	10
F (mm)	15.4
G (mm)	17
L (mm)	41.5
N (mm)	20.2
S (mm)	5.0
S1 (mm)	2.2
S2 (mm)	1.6