

Mod. 6512 - Series 6000 fittings

Product code: 6512 8-1/4

Datasheet creation date: 19/05/2026 09:02

Check the most updated document online [click here](#)



TECHNICAL DATA

Mod.	6512 8-1/4
------	------------

Mod. 6512 - Series 6000 fittings

Product code: 6512 8-1/4

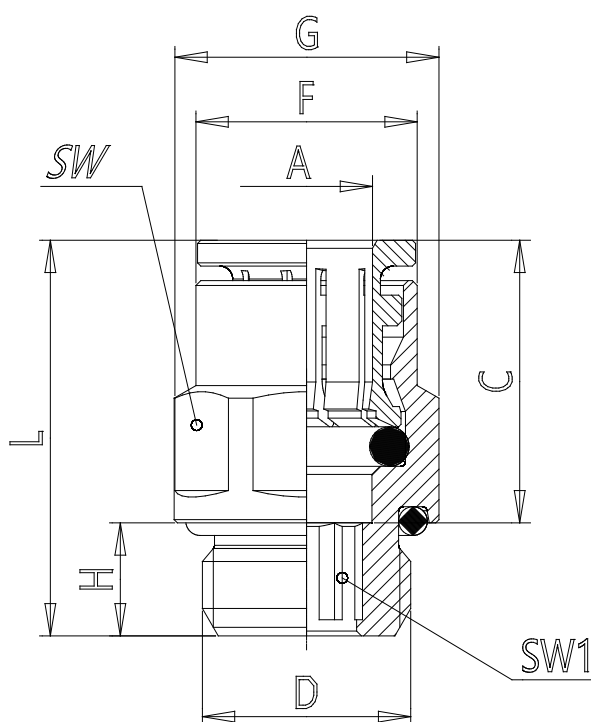

DIMENSIONS

A (mm)	8
D (mm)	G1/4
C (mm)	17.5
F (mm)	13.7
G (mm)	16.4
H (mm)	7.0
L (mm)	24.5
SW (mm)	15
SW1 (mm)	6.0
Weight (g)	17