

Mod. 6512 - Series 6000 fittings

Product code: 6512 4-1/4

Datasheet creation date: 19/05/2026 18:02

Check the most updated document online [click here](#)



TECHNICAL DATA

Mod.	6512 4-1/4
------	------------

Mod. 6512 - Series 6000 fittings

Product code: 6512 4-1/4

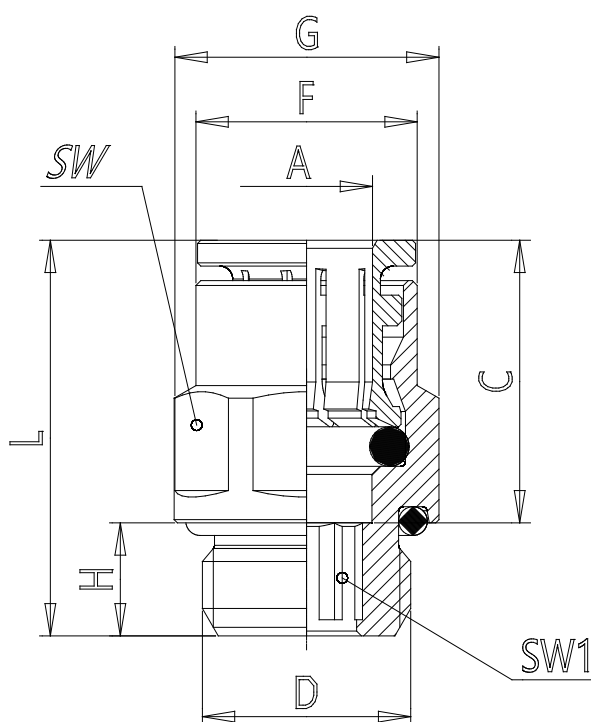

DIMENSIONS

A (mm)	4
D (mm)	G1/4
C (mm)	14.0
F (mm)	8.8
G (mm)	16.4
H (mm)	7.0
L (mm)	20.5
SW (mm)	15
SW1 (mm)	2.5
Weight (g)	14