

Mod. 6512 - Series 6000 fittings

Product code: 6512 12-3/8

Datasheet creation date: 19/05/2026 18:02

Check the most updated document online [click here](#)



TECHNICAL DATA

Mod.	6512 12-3/8
------	-------------

Mod. 6512 - Series 6000 fittings

Product code: 6512 12-3/8

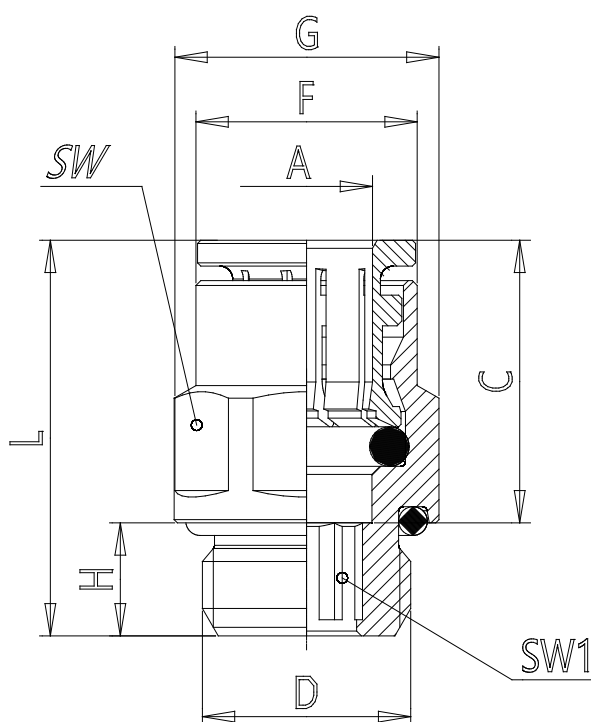

DIMENSIONS

A (mm)	12
D (mm)	G3/8
C (mm)	19.2
F (mm)	18.3
G (mm)	20.5
H (mm)	7.0
L (mm)	24.0
SW (mm)	19
SW1 (mm)	9.0
Weight (g)	24