

Mod. 6512 - Series 6000 fittings

Product code: 6512 10-1/4

Datasheet creation date: 19/05/2026 08:53

Check the most updated document online [click here](#)



TECHNICAL DATA

Mod.	6512 10-1/4
------	-------------

Mod. 6512 - Series 6000 fittings

Product code: 6512 10-1/4

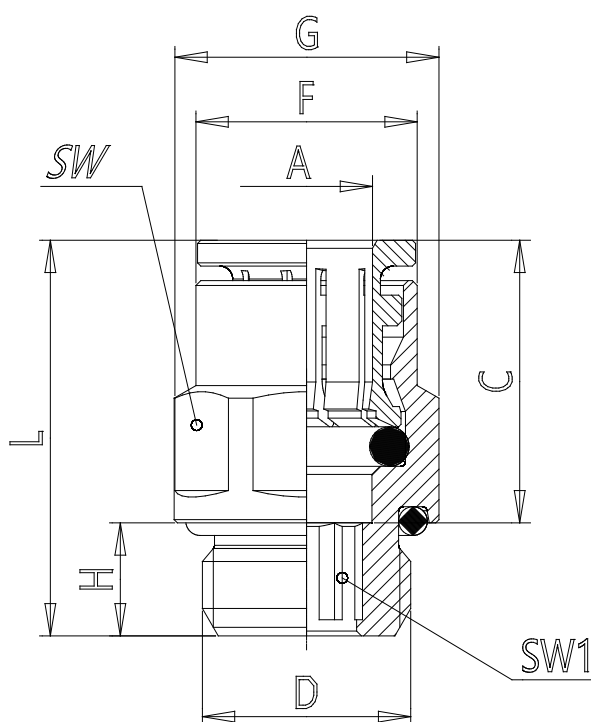

DIMENSIONS

A (mm)	10
D (mm)	G1/4
C (mm)	20.2
F (mm)	15.4
G (mm)	18.5
H (mm)	7.0
L (mm)	30.0
SW (mm)	17
SW1 (mm)	7.0
Weight (g)	26