

## 3/2-way solenoid valve - Mod. 638/648

Product code: 648-150-A63

Datasheet creation date: 19/05/2026 16:53

Check the most updated document online [click here](#)



### TECHNICAL DATA

<b>Cod.</b>	648-150-A6
<b>Voltage</b>	3 = 24 V DC - 10 W
<b>Version</b>	= Standard

## 3/2-way solenoid valve - Mod. 638/648

Product code: 648-150-A63

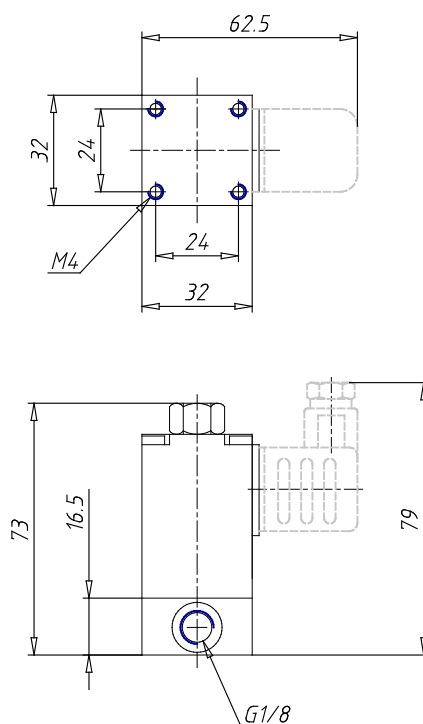

### DIMENSIONS

<b>Thread port</b>	G1/8
<b>Function</b>	3/2 N.A.
<b>Orifice (Ø mm)</b>	2
<b>Qn (NI/mm)</b>	80
<b>Pressure min-max (bar)</b>	0÷8