

Mod. 6432 - Series 6000 micro fittings

Product code: 6432 3-M5

Datasheet creation date: 19/05/2026 18:02

Check the most updated document online [click here](#)



TECHNICAL DATA

Mod.	6432 3-M5
------	-----------

Mod. 6432 - Series 6000 micro fittings

Product code: 6432 3-M5

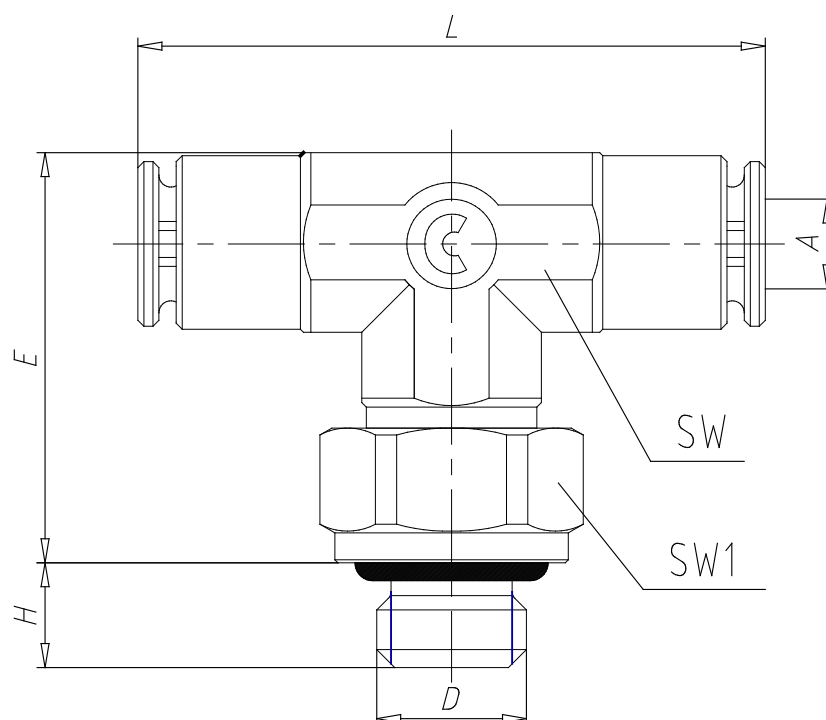

DIMENSIONS

A (mm)	3
D	M5
E (mm)	13.7
H (mm)	3.5
L (mm)	21.4
SW (mm)	6
SW1 (mm)	8
O - Ring	with O - Ring assembled