

## Cylinders - aluminium profile ISO 15552 (ex DIN/ISO 6431 / VDMA 24562) - Series 61

Product code: 61M2P063A0320

Datasheet creation date: 19/05/2026 09:03

Check the most updated document online [click here](#)



### TECHNICAL DATA

<b>Series</b>	61
<b>Diameter (mm)</b>	63
<b>Version</b>	M = magnetic standard
<b>Operation</b>	2=double acting (front and rear cushioning)
<b>Materials</b>	P = standard: AL end-blocks and piston, rolled stainless steel AISI 420B rod, anodized AL profile tube, zinc-plated steel tie-rods and tie-rod nuts, PU seals
<b>Construction</b>	A = standard with lock nut for rod
<b>Stroke type</b>	= standard
<b>Stroke (mm)</b>	320
<b>Seal options</b>	= standard
<b>Rod length (mm)</b>	0
<b>(mm)</b>	0
<b>Protection options</b>	= standard
<b>Certifications</b>	= standard

## Cylinders - aluminium profile ISO 15552 (ex DIN/ISO 6431 / VDMA 24562) - Series 61

Product code: 61M2P063A0320

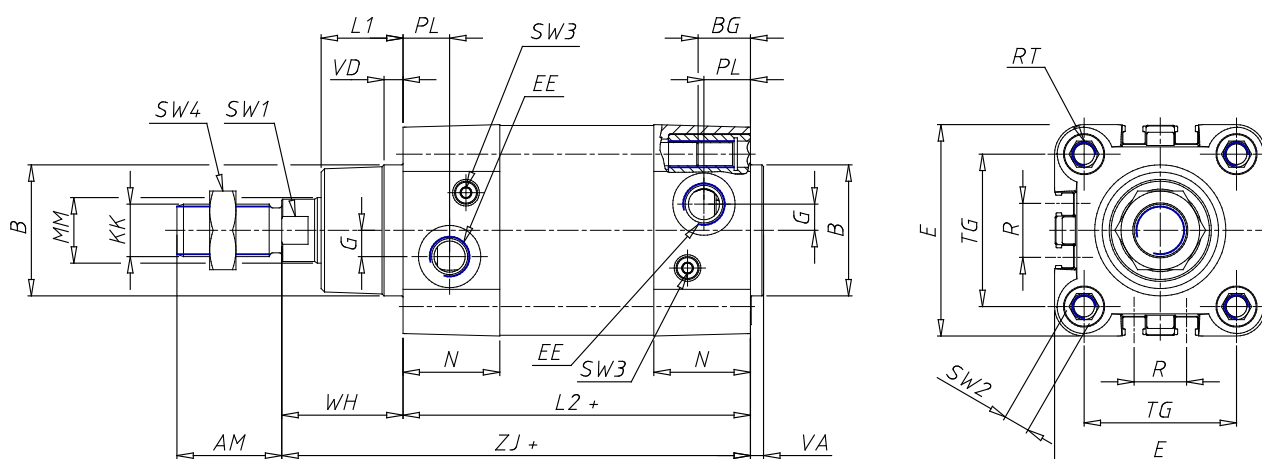

### DIMENSIONS

MM (mm)	20
KK	M16x1,5
B d11 (mm)	45
PL (mm)	21
L1 (mm)	26
L11 (mm)	26
L12 (mm)	82
AM (mm)	32
VA (mm)	4
VAX (mm)	4
EE	G3/8
WH (mm)	37
L2 (mm)	121.0
ZM (mm)	-
ZJ (mm)	158
ZMX (mm)	195
ZJX (mm)	158
VD (mm)	6
N (mm)	36.5
BG (mm)	16.0
RT	M8
TG (mm)	56.5
G (mm)	8.0

R (mm)	28.0
E (mm)	75.0
SW1 (mm)	17
SW2 (mm)	8
SW3 (mm)	3
SW4 (mm)	24
Cushion stroke front spring	17
Cushion stroke rear spring	16
L3 (mm)	230.0
L4 (mm)	15
L5 (mm)	16
L6 (mm)	29.5
L7 (mm)	49.5
L8 (mm)	70
L9 (mm)	121.0
ø D (mm)	20
ø D1 d11 (mm)	45.0
ø D2 (mm)	60
ø D3 f6 (mm)	38
± 0.15 (mm)	56.5
GX	G1/8
H (mm)	40.0
H1 (mm)	75.0