

Cylinders - aluminium profile ISO 15552 (ex DIN/ISO 6431 / VDMA 24562) - Series 61

Product code: 61M2P040A0400

Datasheet creation date: 19/05/2026 08:42

Check the most updated document online [click here](#)



TECHNICAL DATA

Series	61
Diameter (mm)	40
Version	M = magnetic standard
Operation	2=double acting (front and rear cushioning)
Materials	P = standard: AL end-blocks and piston, rolled stainless steel AISI 420B rod, anodized AL profile tube, zinc-plated steel tie-rods and tie-rod nuts, PU seals
Construction	A = standard with lock nut for rod
Stroke type	= standard
Stroke (mm)	400
Seal options	= standard
Rod length (mm)	0
(mm)	0
Protection options	= standard
Certifications	= standard

Cylinders - aluminium profile ISO 15552 (ex DIN/ISO 6431 / VDMA 24562) - Series 61

Product code: 61M2P040A0400

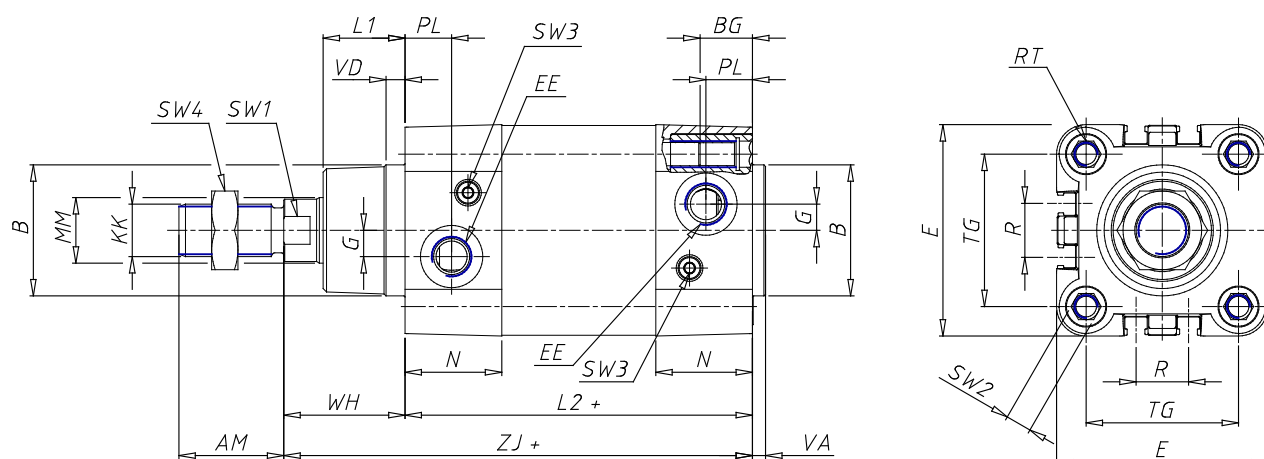

DIMENSIONS

MM (mm)	16
KK	M12x1,25
B d11 (mm)	35
PL (mm)	15
L1 (mm)	21
L11 (mm)	21
L12 (mm)	65
AM (mm)	24
VA (mm)	4
VAX (mm)	4
EE	G1/4
WH (mm)	30
L2 (mm)	105.0
ZM (mm)	-
ZJ (mm)	135
ZMX (mm)	165
ZJX (mm)	135
VD (mm)	5
N (mm)	29.0
BG (mm)	16.0
RT	M6
TG (mm)	38.0
G (mm)	5.0

R (mm)	13.5
E (mm)	55.0
SW1 (mm)	13
SW2 (mm)	6
SW3 (mm)	2
SW4 (mm)	19
Cushion stroke front spring	20
Cushion stroke rear spring	17
L3 (mm)	221.5
L4 (mm)	8
L5 (mm)	13
L6 (mm)	22.5
L7 (mm)	38.0
L8 (mm)	50
L9 (mm)	105.0
ø D (mm)	16
ø D1 d11 (mm)	35.0
ø D2 (mm)	40
ø D3 f6 (mm)	28
± 0.15 (mm)	38.0
GX	G1/8
H (mm)	30.0
H1 (mm)	53.0