

3/2-way solenoid valve Mod. 600 - Mod. 600

Product code: 600-450-A63

Datasheet creation date: 19/05/2026 08:47

Check the most updated document online [click here](#)



TECHNICAL DATA

Cod.	600-450-A6
Voltage	3 = 24 V DC - 10 W
Version	= Standard

3/2-way solenoid valve Mod. 600 - Mod. 600

Product code: 600-450-A63

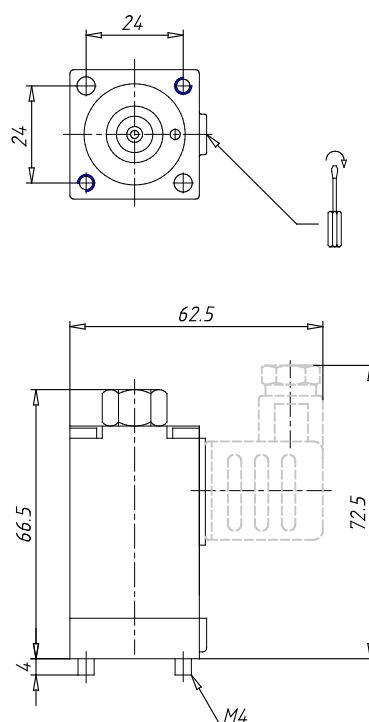

DIMENSIONS

Interface	Rotatable
Function	3/2 N.C.
Orifice (Ø mm)	2
Qn (Nl/mm)	106
Pressure min-max (bar)	0÷10