

Manually operated valves - Series 1,3,4

Product code: 474-905

Datasheet creation date: 19/05/2026 08:50

Check the most updated document online [click here](#)



TECHNICAL DATA

Mod.	474-905
Actuating force (N)	10
Operating pressure (bar)	-0.9+10
Flow rate (NI/min)	1250

Manually operated valves - Series 1,3,4

Product code: 474-905

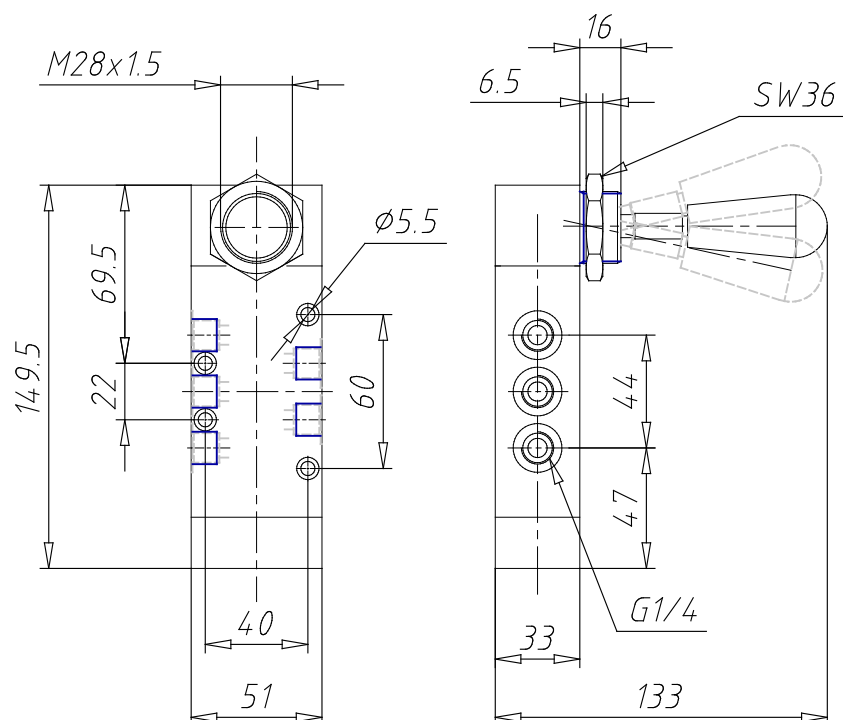

DIMENSIONS

Mod.	474-905
Actuating force (N)	10
Operating pressure (bar)	-0.9÷10
Flow rate (NI/min)	1250