

Anti-rotation guide units - Series 45

Product code: 45NHT025A0250

Datasheet creation date: 19/05/2026 16:36

Check the most updated document online [click here](#)



TECHNICAL DATA

Series	45
Version	N = standard
Operation	HT = "H" self lubricating guide
Diameter (mm)	25
Materials	A = anodized aluminium body, stainless steel columns AISI 420B
Stroke (mm)	250

Anti-rotation guide units - Series 45

Product code: 45NHT025A0250

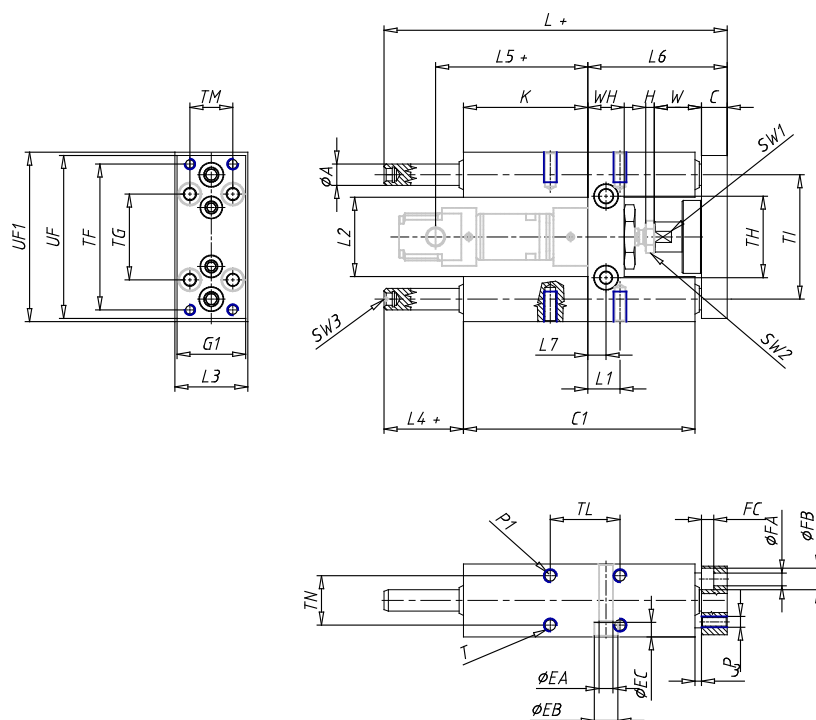

DIMENSIONS

TF (mm)	68
TG (mm)	40.0
TH (mm)	38.0
TI (mm)	58
TM (mm)	20
TL (mm)	32.5
TN (mm)	23
UF1 (mm)	79
UF (mm)	76
G1 (mm)	32
A (mm)	10
WH (mm)	17
C1 (mm)	108
H (mm)	6
W (mm)	17
C (mm)	12
K (mm)	58
L (mm)	160.0
L1 (mm)	15
L2 (mm)	37.0
L3 (mm)	34
L4 (mm)	37
L5 (mm)	76.0

L6 (mm)	65.0
L7 (mm)	8.5
L8 (mm)	0
P	M5
P1	M6
T (mm)	14
EA (mm)	6.5
EB (mm)	11
EC (mm)	6.8
FA (mm)	5.5
FB (mm)	10.0
FC (mm)	5.7
SW1 (mm)	13
SW2 (mm)	17
SW3 (mm)	6