

Manually operated valves - Series 1,3,4

Product code: 454-905

Datasheet creation date: 19/05/2026 08:50

Check the most updated document online [click here](#)



TECHNICAL DATA

| | |
|---------------------------------|---------|
| Mod. | 454-905 |
| Actuating force (N) | 37 |
| Operating pressure (bar) | -0.9+10 |
| Flow rate (Nl/min) | 1250 |

Manually operated valves - Series 1,3,4

Product code: 454-905

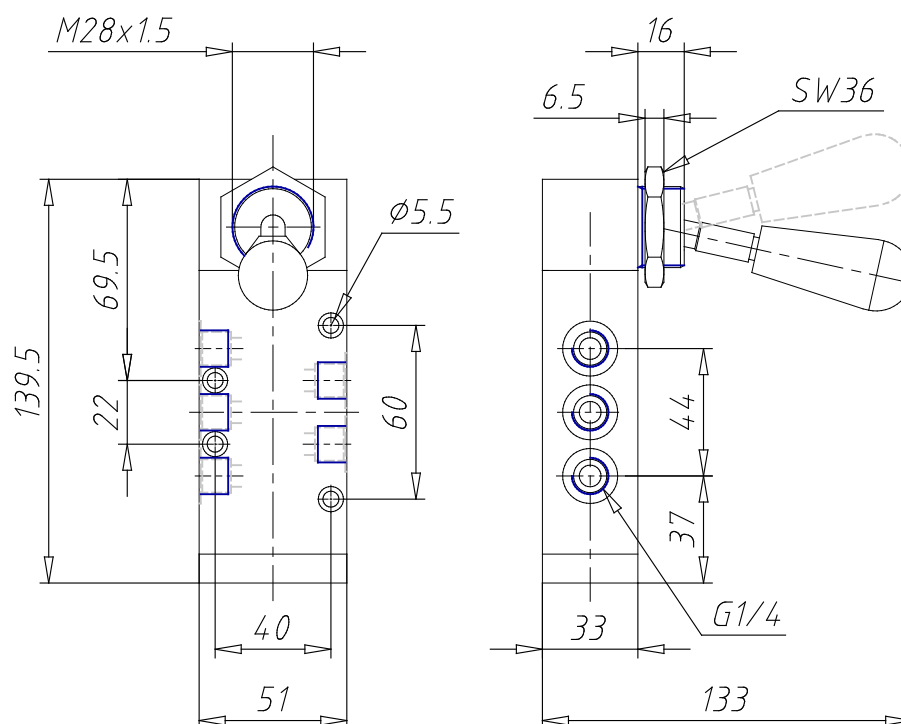

DIMENSIONS

| | |
|---------------------------------|---------|
| Mod. | 454-905 |
| Actuating force (N) | 37 |
| Operating pressure (bar) | -0.9÷10 |
| Flow rate (NI/min) | 1250 |