

5/2-way valve, G1/2 port, bistable - Series 4

Product code: 452C-34

Datasheet creation date: 19/05/2026 17:06

Check the most updated document online [click here](#)



TECHNICAL DATA

Mod.	452C-34
Mounting	Without base
Function	5/2
Flow rate	2400
P. min pilot. (bar)	2

5/2-way valve, G1/2 port, bistable - Series 4

Product code: 452C-34

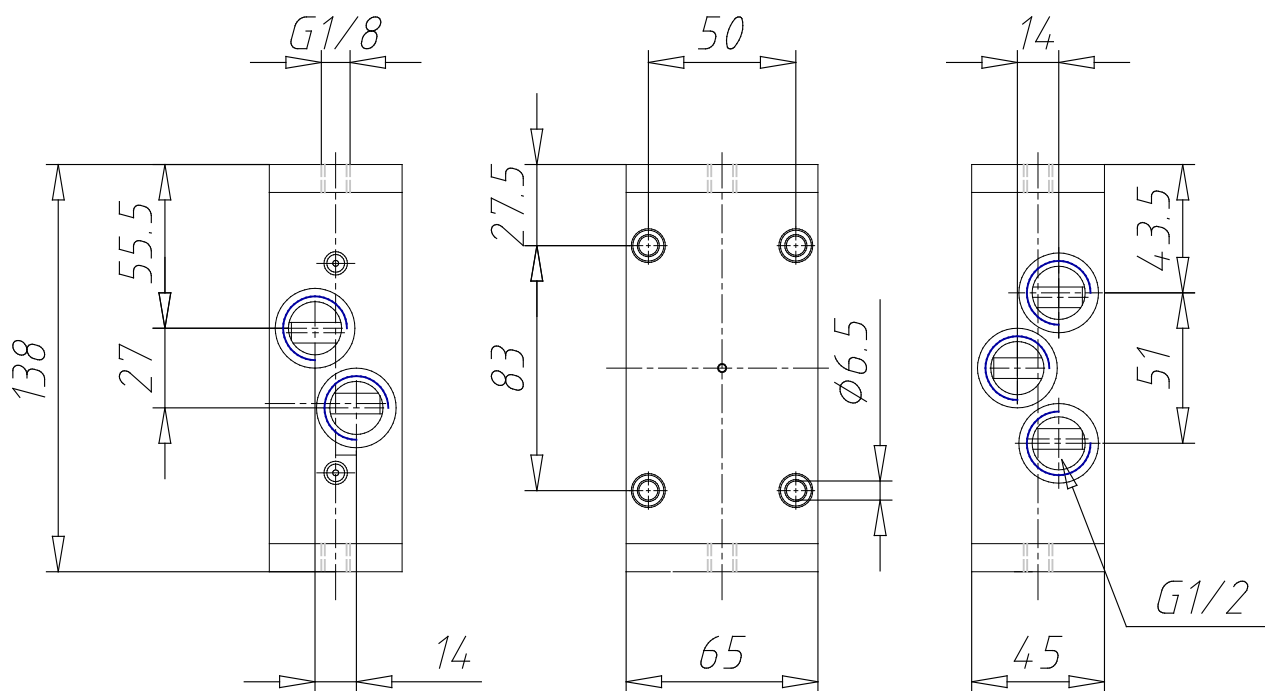

DIMENSIONS

Mod.	452C-34
Mounting	Without base
Function	5/2
Flow rate	2400
P. min pilot. (bar)	2