

## 5/2-way valve, G1/2 port, bistable - Series 4

Product code: 452C-33

Datasheet creation date: 19/05/2026 17:05

Check the most updated document online [click here](#)



### TECHNICAL DATA

<b>Mod.</b>	452C-33
<b>Mounting</b>	Without base
<b>Function</b>	5/2
<b>Flow rate</b>	2400
<b>P. min pilot. (bar)</b>	2

## 5/2-way valve, G1/2 port, bistable - Series 4

Product code: 452C-33

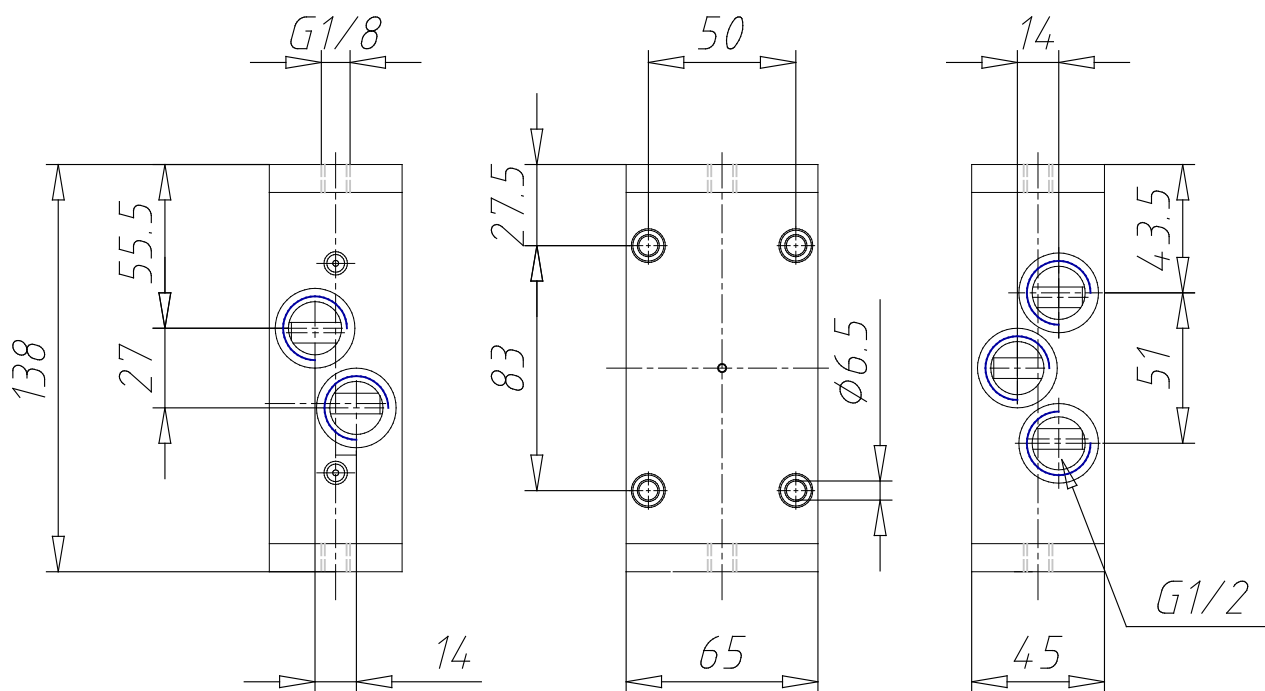

### DIMENSIONS

<b>Mod.</b>	452C-33
<b>Mounting</b>	Without base
<b>Function</b>	5/2
<b>Flow rate</b>	2400
<b>P. min pilot. (bar)</b>	2