

Hydraulic brakes - Series 43

Product code: 43N-PTV-40-300

Datasheet creation date: 19/05/2026 15:55

Check the most updated document online [click here](#)



TECHNICAL DATA

Series	43
Diameter (mm)	40
Version	N = standard
Bowl	P = parallel tank
Regulation	T = traction (adjustment of rod thrust)
Valve	V = STOP valve
Stroke (mm)	300

Hydraulic brakes - Series 43

Product code: 43N-PTV-40-300

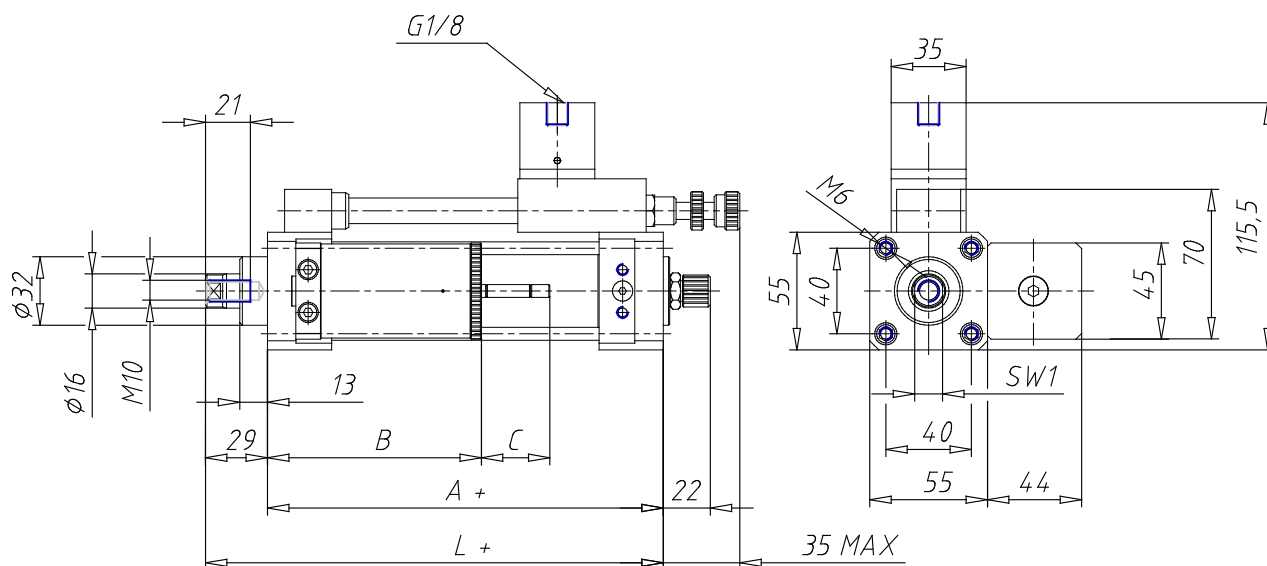

DIMENSIONS

A (mm)	85
B (mm)	150
C (mm)	67
L (mm)	114
SW1 (mm)	13