

Hydraulic brakes - Series 43

Product code: 43N-PTA-40-200

Datasheet creation date: 19/05/2026 15:53

Check the most updated document online [click here](#)



TECHNICAL DATA

Series	43
Diameter (mm)	40
Version	N = standard
Bowl	P = parallel tank
Regulation	T = traction (adjustment of rod thrust)
Valve	A = SKIP valve
Stroke (mm)	200

Hydraulic brakes - Series 43

Product code: 43N-PTA-40-200

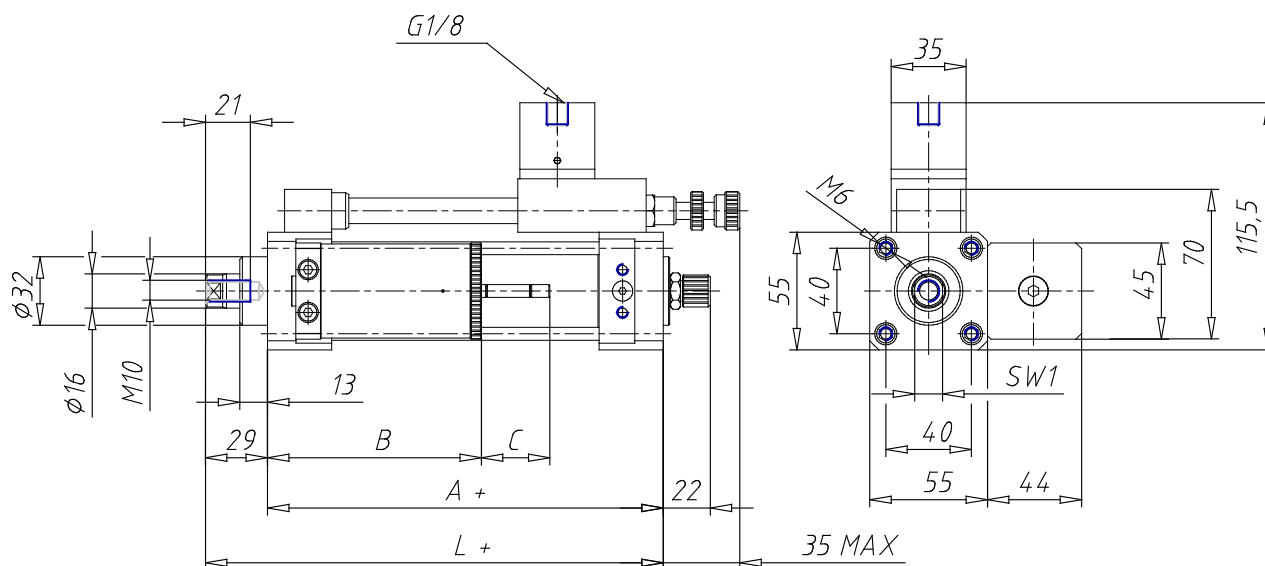

DIMENSIONS

A (mm)	85
B (mm)	125
C (mm)	47
L (mm)	114
SW1 (mm)	13