

Hydraulic brakes - Series 43

Product code: 43N-LTB-40-400

Datasheet creation date: 20/05/2026 03:24

Check the most updated document online [click here](#)



TECHNICAL DATA

Series	43
Diameter (mm)	40
Version	N = standard
Bowl	L = inline tank
Regulation	T = traction (adjustment of rod thrust)
Valve	B = SKIP + STOP valve
Stroke (mm)	400

Hydraulic brakes - Series 43

Product code: 43N-LTB-40-400

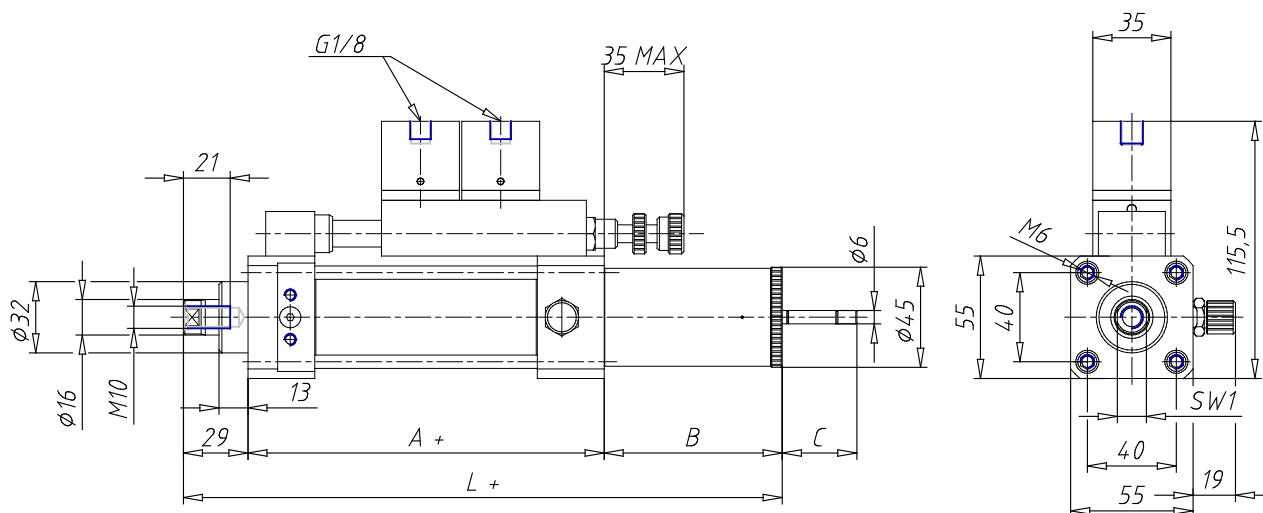

DIMENSIONS

A (mm)	85
B (mm)	145
C (mm)	86
L (mm)	214
SW1 (mm)	13