

Hydraulic brakes - Series 43

Product code: 43N-LTA-40-450

Datasheet creation date: 19/05/2026 15:53

Check the most updated document online [click here](#)



TECHNICAL DATA

| | |
|----------------------|---|
| Series | 43 |
| Diameter (mm) | 40 |
| Version | N = standard |
| Bowl | L = inline tank |
| Regulation | T = traction (adjustment of rod thrust) |
| Valve | A = SKIP valve |
| Stroke (mm) | 450 |

Hydraulic brakes - Series 43

Product code: 43N-LTA-40-450

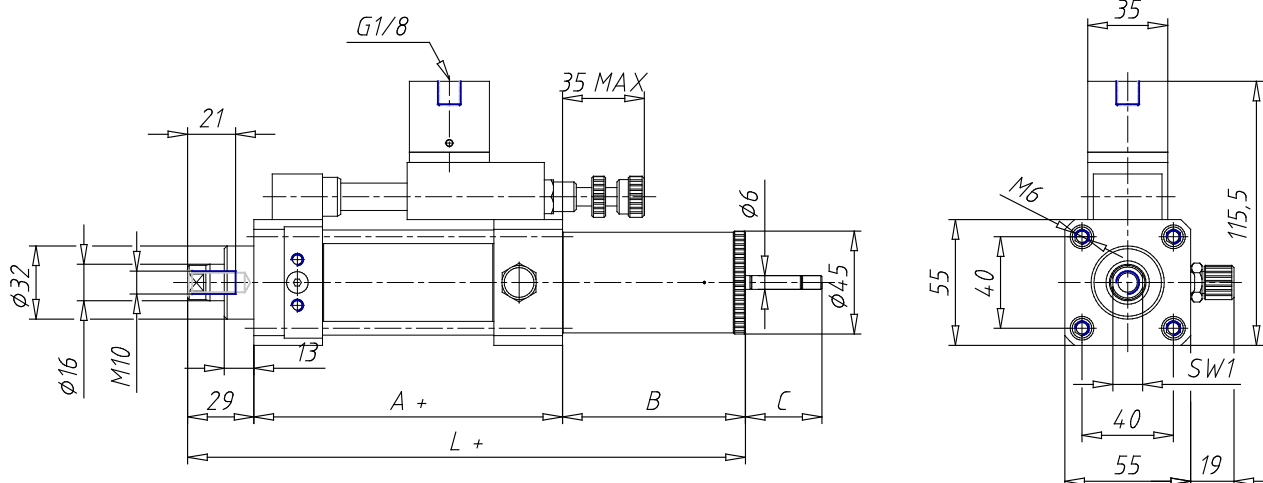

DIMENSIONS

| | |
|-----------------|-----|
| A (mm) | 85 |
| B (mm) | 145 |
| C (mm) | 86 |
| L (mm) | 214 |
| SW1 (mm) | 13 |