

Manually operated valves - Series 1,3,4

Product code: 434-900

Datasheet creation date: 20/05/2026 09:26

Check the most updated document online [click here](#)



TECHNICAL DATA

Mod.	434-900
Actuating force (N)	5
Operating pressure (bar)	-0.9+10
Flow rate (Nl/min)	1250

Manually operated valves - Series 1,3,4

Product code: 434-900

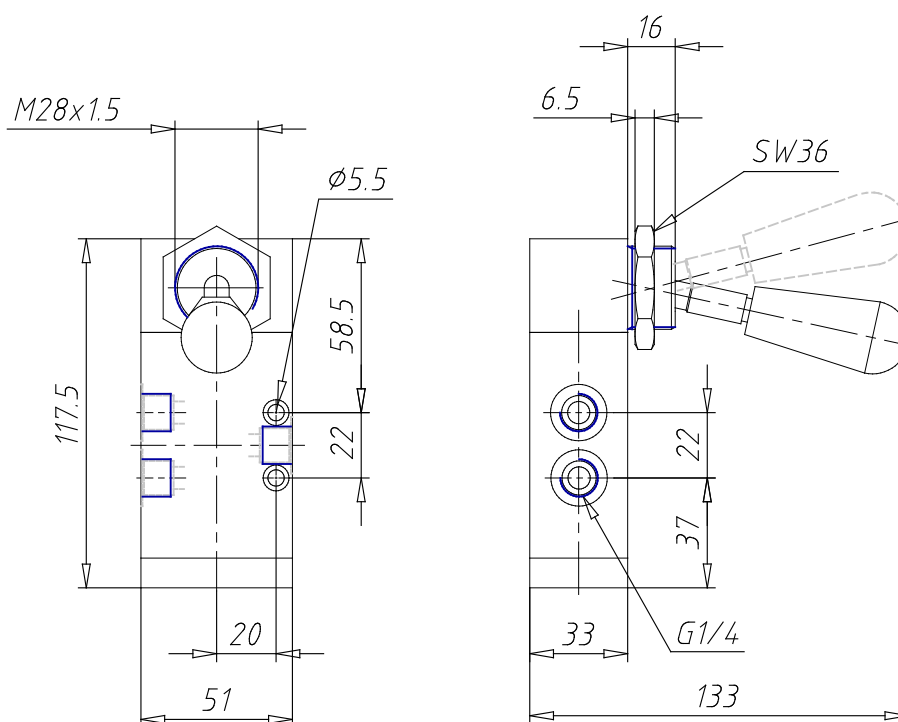

DIMENSIONS

Mod.	434-900
Actuating force (N)	5
Operating pressure (bar)	-0.9÷10
Flow rate (NI/min)	1250