

3/2-way valve, G1/4 port, monostable - Series 4

Product code: 434-35

Datasheet creation date: 19/05/2026 08:48

Check the most updated document online [click here](#)



TECHNICAL DATA

Mod.	434-35
Mounting	Without base/conv.
Function	3/2 NC
Flow rate	1250
P. min pilot. (bar)	2.5

3/2-way valve, G1/4 port, monostable - Series 4

Product code: 434-35

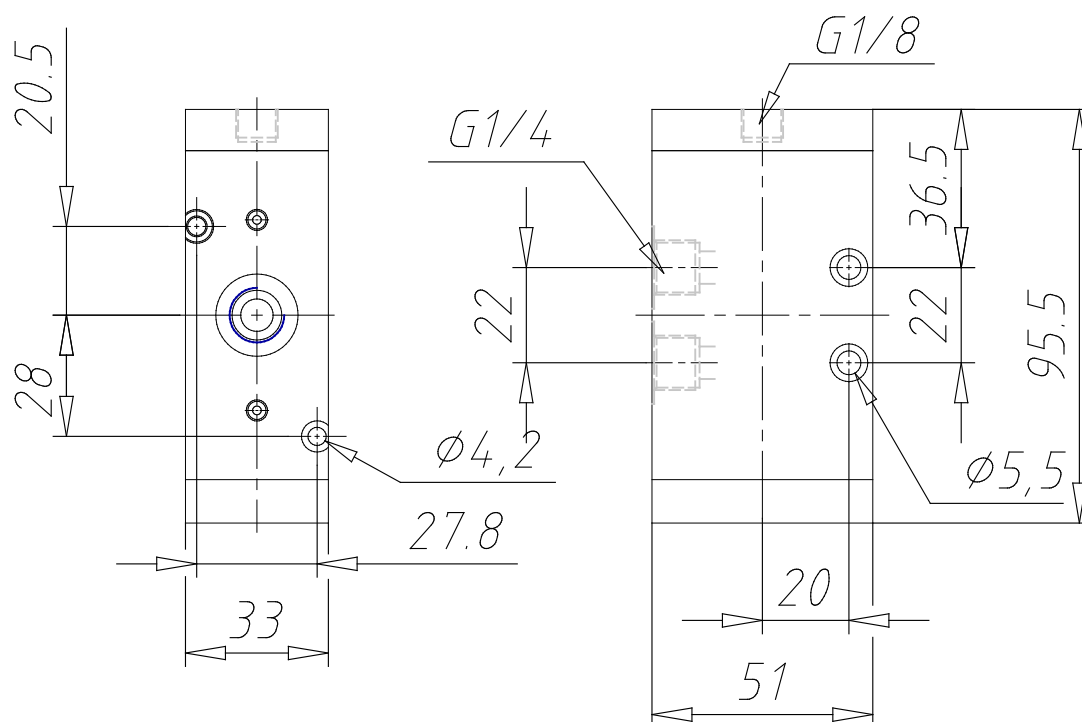

DIMENSIONS

Mod.	434-35
Mounting	Without base/conv.
Function	3/2 NC
Flow rate	1250
P. min pilot. (bar)	2.5