

## Manually operated valves - Series 1,3,4

Product code: 378-900

Datasheet creation date: 19/05/2026 17:10

Check the most updated document online [click here](#)



### TECHNICAL DATA

<b>Mod.</b>	378-900
<b>Actuating force (N)</b>	5
<b>Operating pressure (bar)</b>	-0.9+10
<b>Flow rate (Nl/min)</b>	700

## Manually operated valves - Series 1,3,4

Product code: 378-900

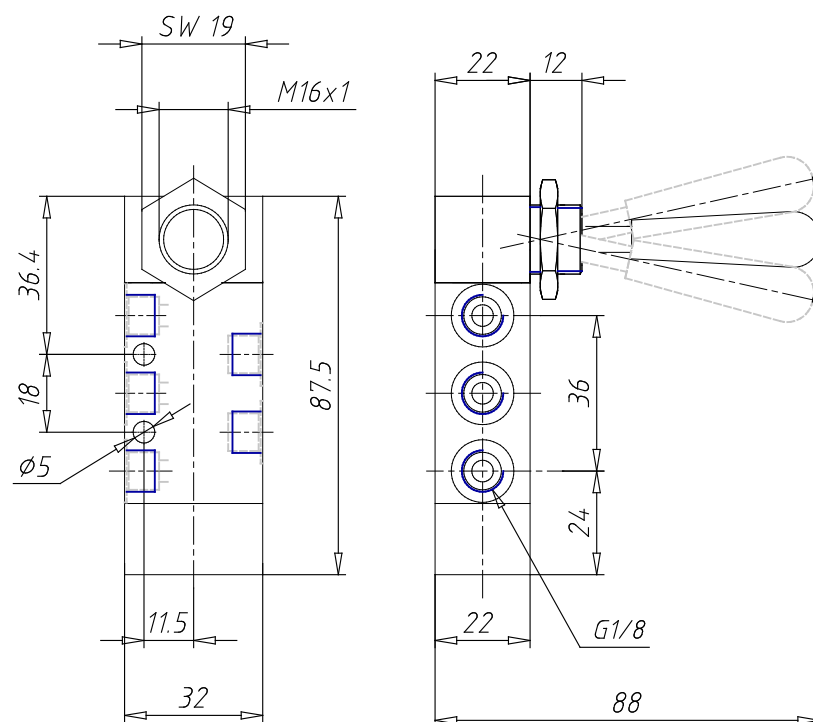

### DIMENSIONS

<b>Mod.</b>	378-900
<b>Actuating force (N)</b>	5
<b>Operating pressure (bar)</b>	-0.9÷10
<b>Flow rate (NI/min)</b>	700