

## Mechanically operated valves - Series 1 and 3 / 358-965

Product code: 358-965

Datasheet creation date: 19/05/2026 17:10

Check the most updated document online [click here](#)



### TECHNICAL DATA

<b>Mod.</b>	358-965
<b>Operating pressure (bar)</b>	0,9÷10 bar
<b>Flow rate</b>	700NL/min
<b>Actuating force</b>	16N
<b>Activity</b>	Actuating unidirectional lever / roller

## Mechanically operated valves - Series 1 and 3 / 358-965

Product code: 358-965

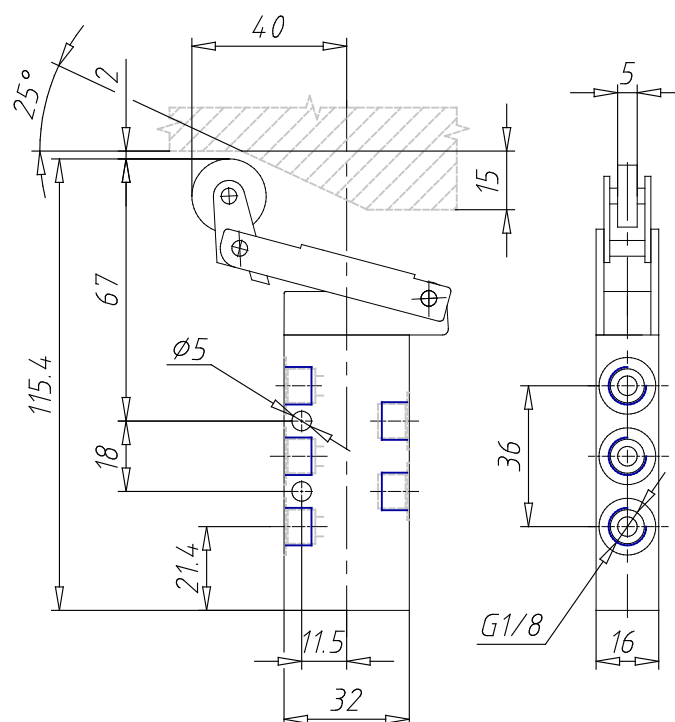

### DIMENSIONS

<b>Mod.</b>	358-965
<b>Operating pressure (bar)</b>	0,9÷10 bar
<b>Flow rate</b>	700NL/min
<b>Actuating force</b>	16N
<b>Activity</b>	Actuating unidirectional lever / roller