

5/2-way solenoid valve, G1/8, monostable - Series 3

Product code: 358-015-02

Datasheet creation date: 19/05/2026 08:48

Check the most updated document online [click here](#)



TECHNICAL DATA

Mod.	358-015-02
Function	5/2
Flow rate (NI/min)	700
Operating pressure	2,5 ÷ 10
Pilot pressure	-
Manual override	= bistable standard
Dimensions of the solenoid	No solenoid
Solenoid voltage	

5/2-way solenoid valve, G1/8, monostable - Series 3

Product code: 358-015-02

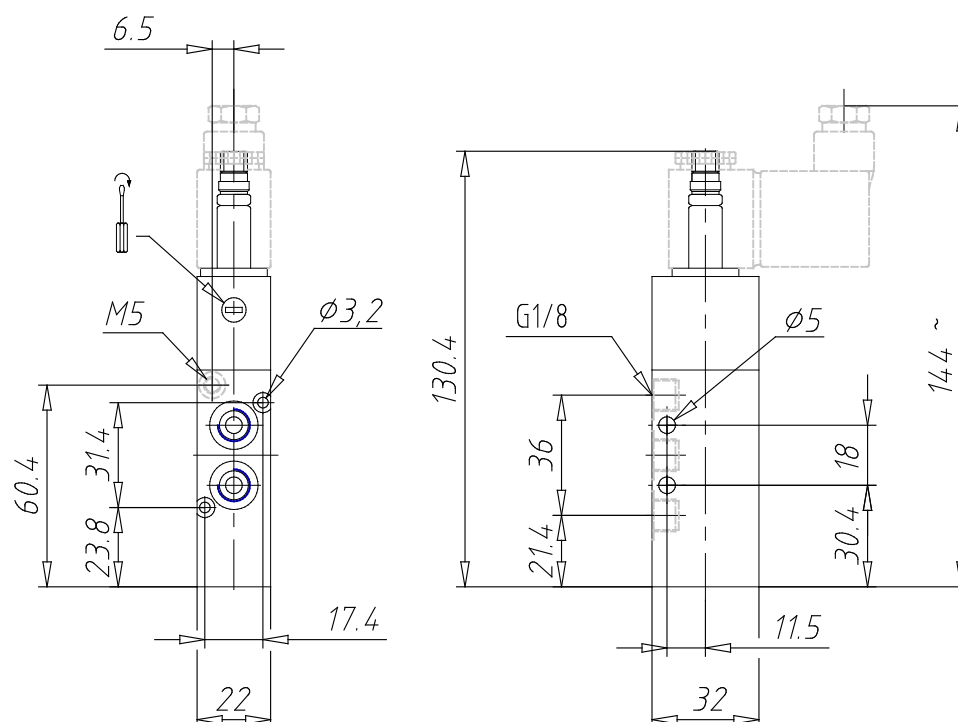

DIMENSIONS

Mod.	358-015-02
Function	5/2
Flow rate (NI/min)	700
Operating pressure	2,5 ÷ 10
Pilot pressure	-
Manual override	= bistable standard
Dimensions of the solenoid	No solenoid
Solenoid voltage	