

sensitive lever spring return - Valves series 348-D15-9A5

Product code: 348-D15-9A5

Datasheet creation date: 19/05/2026 17:09

Check the most updated document online [click here](#)



TECHNICAL DATA

Mod.	348-D15-9A5
Operating pressure (bar)	4+10 bar
Flow rate	700NL/min
Actuating force	2N
Activity	sensitive lever spring return

sensitive lever spring return - Valves series 348-D15-9A5

Product code: 348-D15-9A5

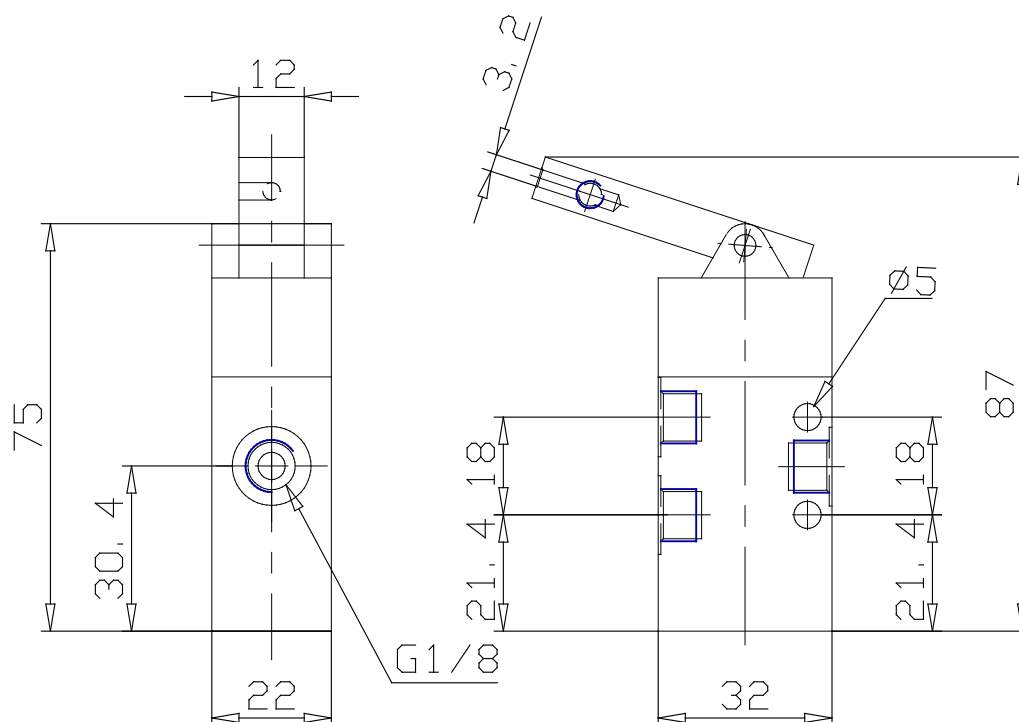

DIMENSIONS

Mod.	348-D15-9A5
Operating pressure (bar)	4÷10 bar
Flow rate	700NL/min
Actuating force	2N
Activity	sensitive lever spring return