

3/2-way solenoid valve, G1/4, monostable - Mod. 334... Mod 344... - Series 3

Product code: 344-015-02

Datasheet creation date: 19/05/2026 18:11

Check the most updated document online [click here](#)



TECHNICAL DATA

Mod.	344-015-02
Mounting	In-line
Function	3/2NO
Flow rate (NI/min)	1300
Operating pressure	2.5 ÷ 10
Pilot pressure	-
Manual override	= bistable, standard
Dimensions of the solenoid	No solenoid
Solenoid voltage	

3/2-way solenoid valve, G1/4, monostable - Mod. 334... Mod 344... - Series 3

Product code: 344-015-02

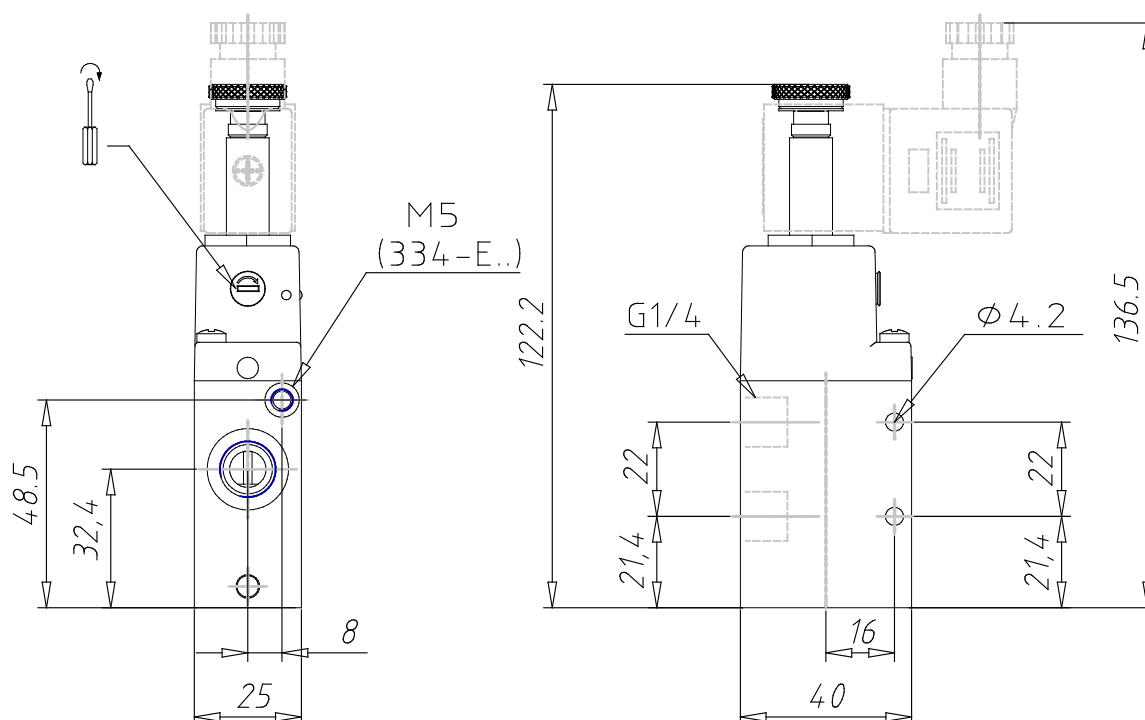

DIMENSIONS

Mod.	344-015-02
Mounting	In-line
Function	3/2NO
Flow rate (NI/min)	1300
Operating pressure	2.5 ÷ 10
Pilot pressure	-
Manual override	= bistable, standard
Dimensions of the solenoid	No solenoid
Solenoid voltage	