

## Manually operated valves - Series 1,3,4

Product code: 338-990

Datasheet creation date: 19/05/2026 08:50

Check the most updated document online [click here](#)



### TECHNICAL DATA

<b>Mod.</b>	338-990
<b>Actuating force (N)</b>	18
<b>Operating pressure (bar)</b>	-0.9+10
<b>Flow rate (Nl/min)</b>	700

## Manually operated valves - Series 1,3,4

Product code: 338-990

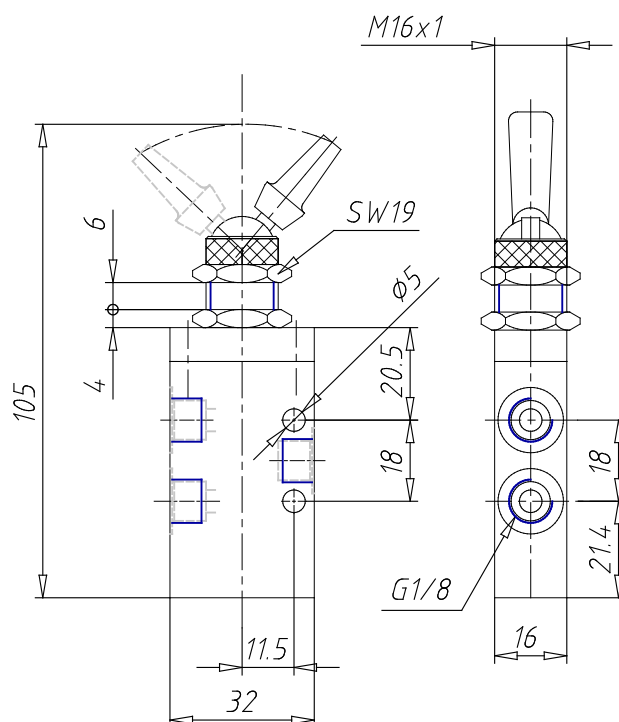

### DIMENSIONS

Mod.	338-990
Actuating force (N)	18
Operating pressure (bar)	-0.9÷10
Flow rate (NI/min)	700