

Manually operated valves - Series 1,3,4

Product code: 338-977

Datasheet creation date: 19/05/2026 17:10

Check the most updated document online [click here](#)



TECHNICAL DATA

Mod.	338-977
Actuating force (N)	35
Operating pressure (bar)	-0.9+10
Flow rate (NI/min)	700

Manually operated valves - Series 1,3,4

Product code: 338-977

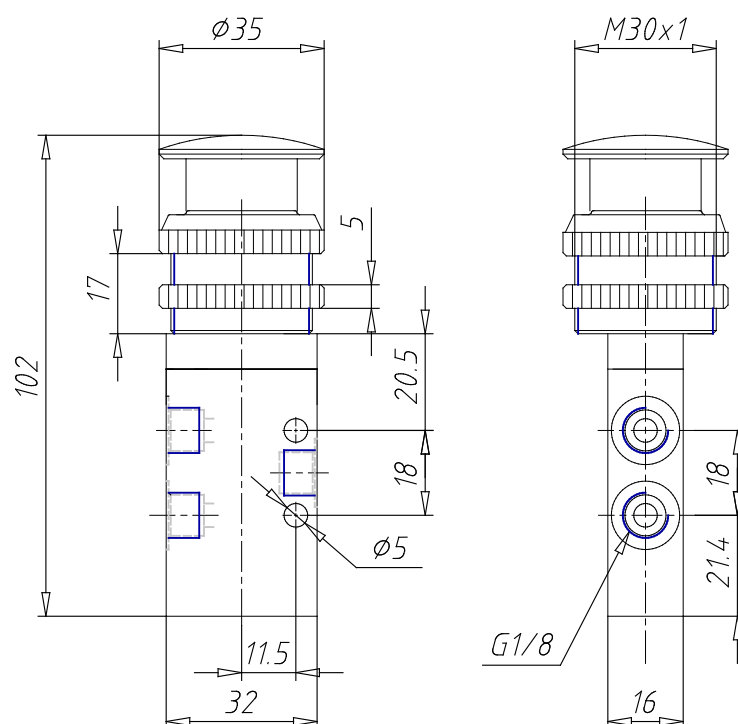

DIMENSIONS

Mod.	338-977
Actuating force (N)	35
Operating pressure (bar)	-0.9÷10
Flow rate (NI/min)	700