

Mechanically operated valves - Series 1 and 3 / 338-955

Product code: 338-955

Datasheet creation date: 19/05/2026 08:50

Check the most updated document online [click here](#)



TECHNICAL DATA

Mod.	338-955
Operating pressure (bar)	0,9÷10 bar
Flow rate	700NL/min
Actuating force	15N
Activity	Actuating lever / roller

Mechanically operated valves - Series 1 and 3 / 338-955

Product code: 338-955

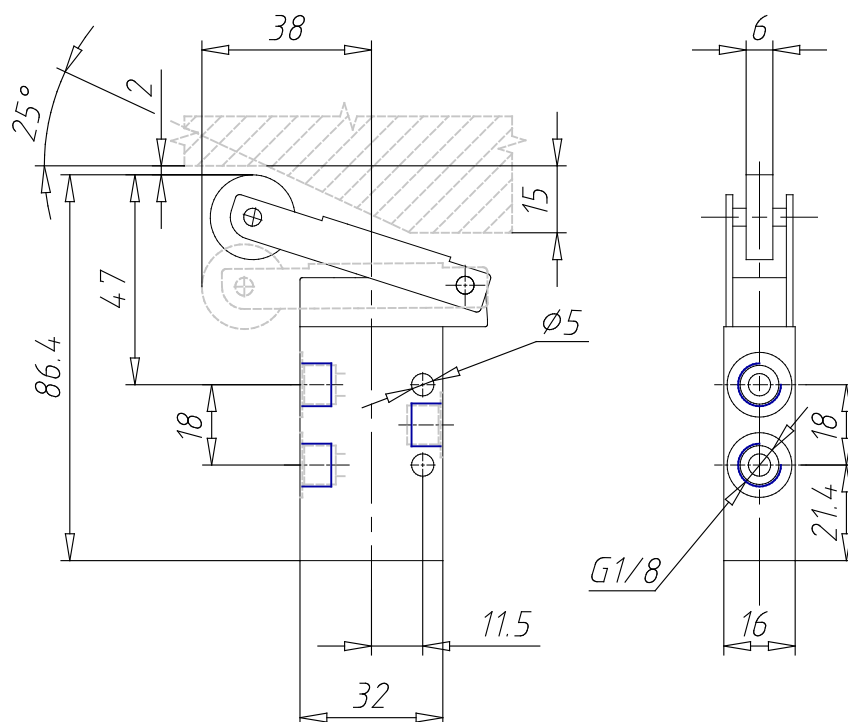

DIMENSIONS

Mod.	338-955
Operating pressure (bar)	0,9÷10 bar
Flow rate	700NL/min
Actuating force	15N
Activity	Actuating lever / roller