

3/2 ways G1/8 solenoid valve, monostable - Series 3

Product code: 338-015-02

Datasheet creation date: 19/05/2026 08:48

Check the most updated document online [click here](#)



TECHNICAL DATA

Mod.	338-015-02
Mounting	in-line
Function	3/2 NC
Flow rate (NI/min)	700
Operating pressure	2.5-10
Manual override	= bistabile standard
Dimensions of the solenoid	No solenoid
Solenoid voltage	

3/2 ways G1/8 solenoid valve, monostable - Series 3

Product code: 338-015-02

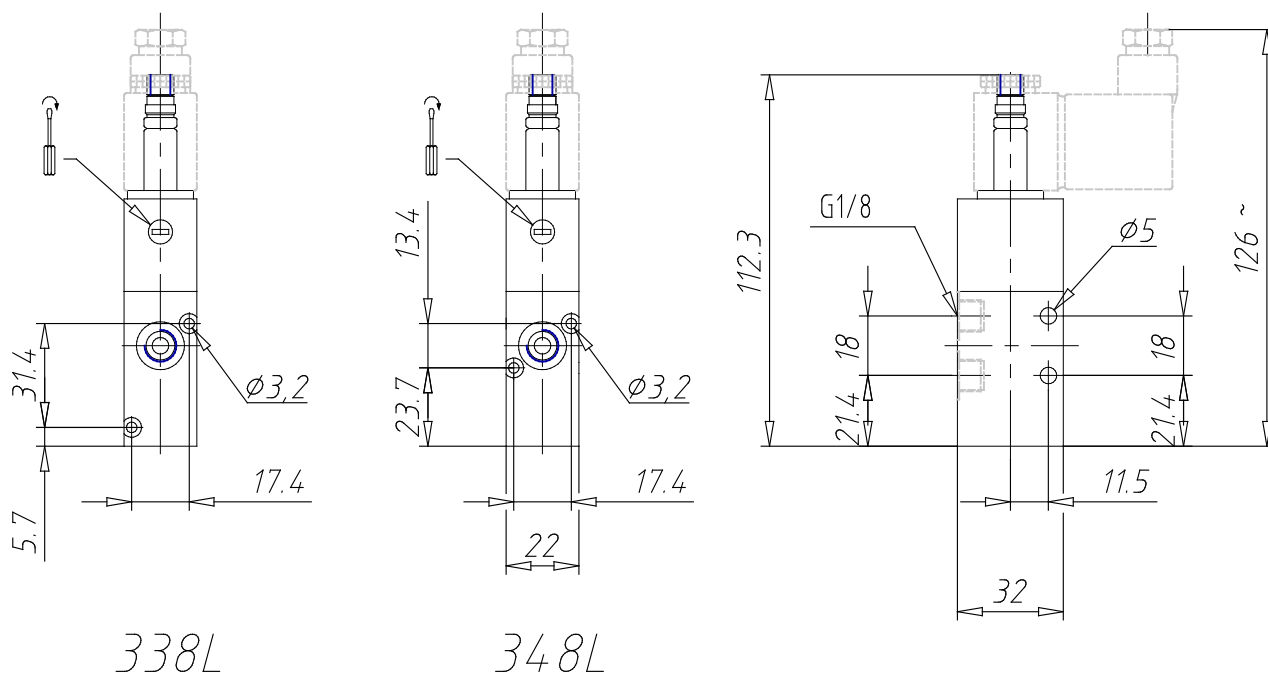

DIMENSIONS

Mod.	338-015-02
Mounting	in-line
Function	3/2 NC
Flow rate (NI/min)	700
Operating pressure	2.5-10
Manual override	= bistabile standard
Dimensions of the solenoid	No solenoid
Solenoid voltage	