

Compact magnetic cylinders - Series 32

Product code: 32R2A040A020

Datasheet creation date: 19/05/2026 08:37

Check the most updated document online [click here](#)



TECHNICAL DATA

Series	32
Version	R=non-rotating with flange only double acting
Operation	2=double-acting
Materials	A = anodized aluminium body, end blocks and piston,
Diameter (mm)	40
Construction	A = standard
Cylinder Stroke (mm)	20
Seal options	= standard
Rod length (mm)	0
Rod length 2 (mm)	0
Certifications	= standard

Compact magnetic cylinders - Series 32

Product code: 32R2A040A020

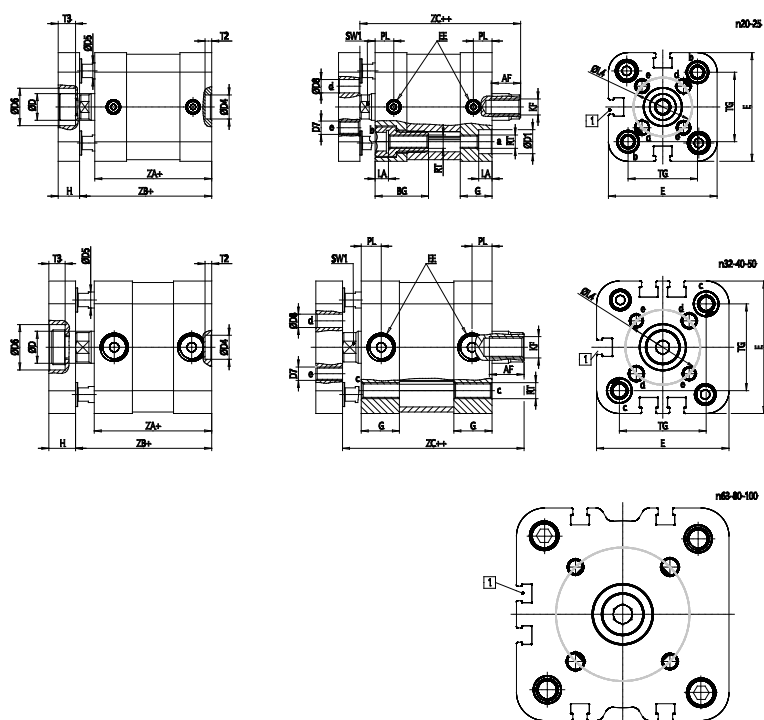

DIMENSIONS

A (mm)	19
AF (mm)	13
BG (mm)	0.0
G (mm)	14.3
Ø (mm)	12
Ø (mm)	0
D4 (mm)	9
D5 (mm)	6
D6 (mm)	17
D7	M5
D8 (mm)	5
E (mm)	57.0
EE	G1\8
H (mm)	10
KF	M8
KK	M10x1,25
LA (mm)	0
L4 (mm)	33
PL (mm)	7.6
RT	M6
SW1 (mm)	10
T2 (mm)	4
T3 (mm)	6

TG (mm)	38.0
ZA (mm)	45.0
ZB (mm)	52.0
ZC (mm)	59