

Silencers - Series 2901

Product code: 2901 1/2

Datasheet creation date: 19/05/2026 08:50

Check the most updated document online [click here](#)



TECHNICAL DATA

Mod.	2901 1/2
Pressure range (Kg / cm² - bar)	max. 10
Flow (NI / min)	3400
Noise treshold (db (A))	86

Silencers - Series 2901

Product code: 2901 1/2

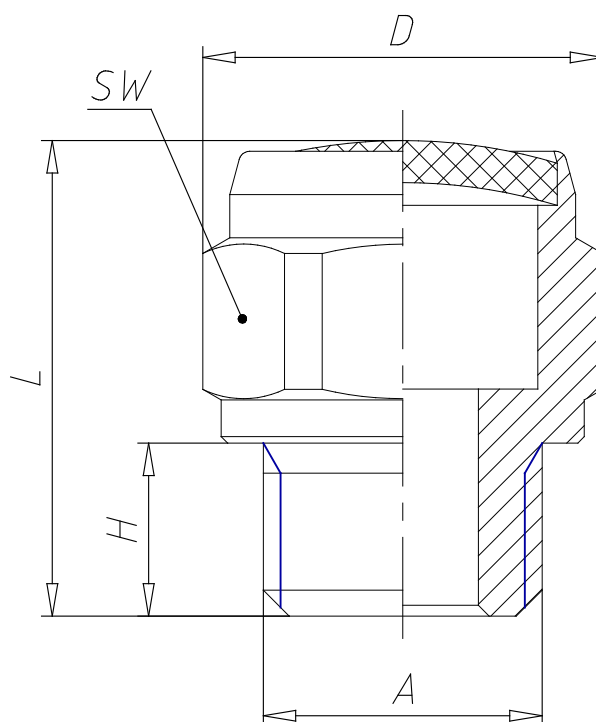

DIMENSIONS

A	G1/2
D (mm)	29.5
H (mm)	8
L (mm)	17.5
SW (mm)	27