

Valves - Series 28

Product code: 2839 3/8

Datasheet creation date: 19/05/2026 17:14

Check the most updated document online [click here](#)



TECHNICAL DATA

Mod.	2839 3/8
------	----------

Valves - Series 28

Product code: 2839 3/8

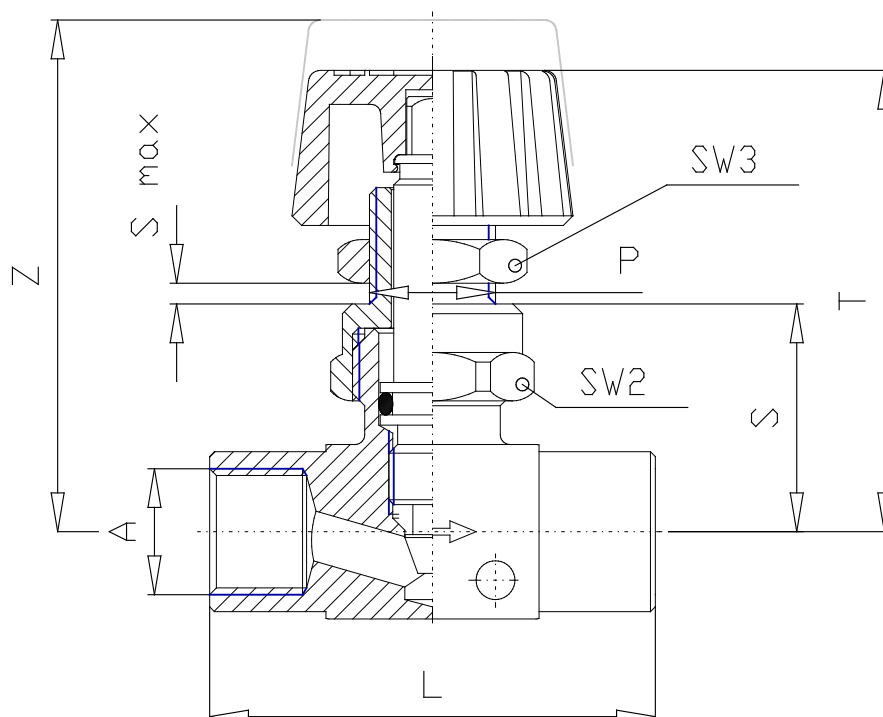

DIMENSIONS

A	G3/8
P	14x1
S	28
T (mm)	56.5
Z (mm)	63.0
S MAX	7
SW2	22
SW3	17