

## Valves - Series 28

Product code: 2839 1/8

Datasheet creation date: 19/05/2026 08:51

Check the most updated document online [click here](#)



### TECHNICAL DATA

Mod.	2839 1/8
------	----------

## Valves - Series 28

Product code: 2839 1/8

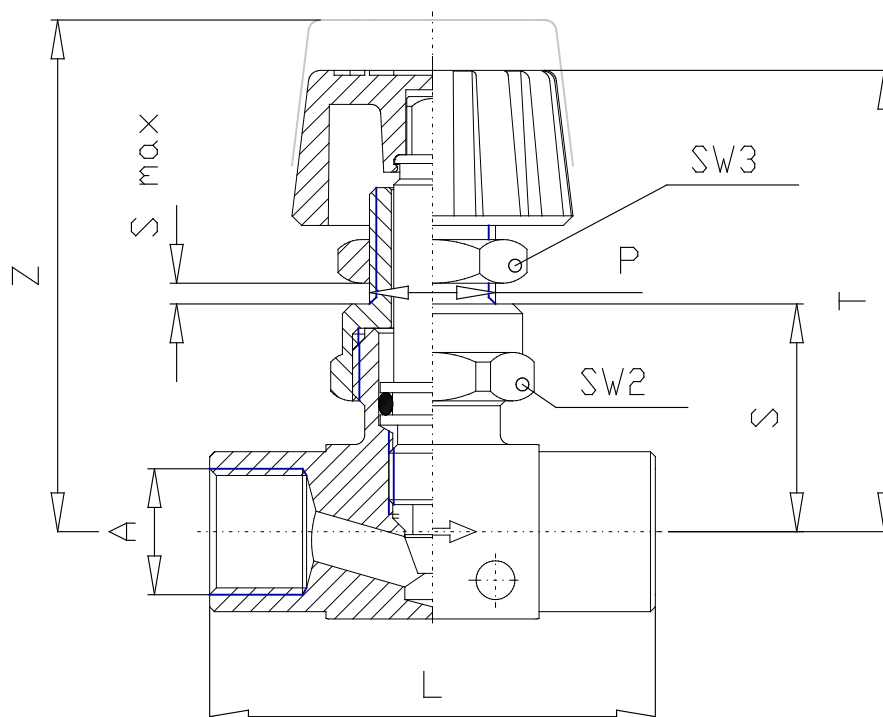

### DIMENSIONS

<b>A</b>	G1/8
<b>P</b>	1/4
<b>S</b>	23
<b>T (mm)</b>	47.0
<b>Z (mm)</b>	52.5
<b>S MAX</b>	7
<b>SW2</b>	19
<b>SW3</b>	17