

Valves - Series 28

Product code: 2829 1/8

Datasheet creation date: 19/05/2026 17:14

Check the most updated document online [click here](#)



TECHNICAL DATA

Mod.	2829 1/8
------	----------

Valves - Series 28

Product code: 2829 1/8

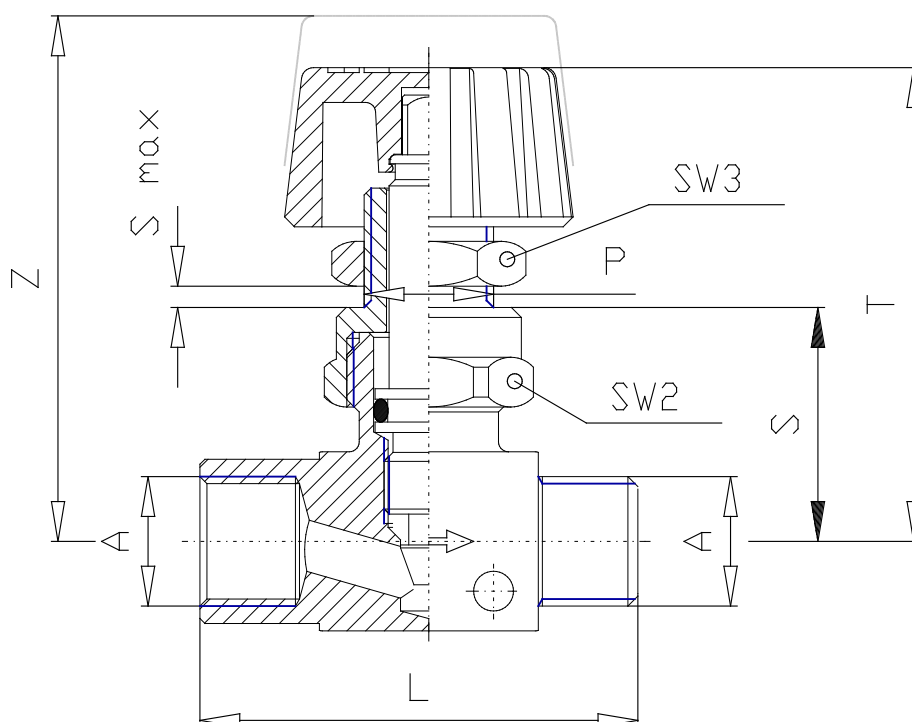

DIMENSIONS

A	G1/8
P	1/4
S	23
T (mm)	47.0
Z (mm)	52.5
S MAX	7
SW2	19
SW3	17