

## Valves - Series 28

Product code: 2820 3/8

Datasheet creation date: 19/05/2026 17:14

Check the most updated document online [click here](#)



### TECHNICAL DATA

Mod.	2820 3/8
------	----------

## Valves - Series 28

Product code: 2820 3/8

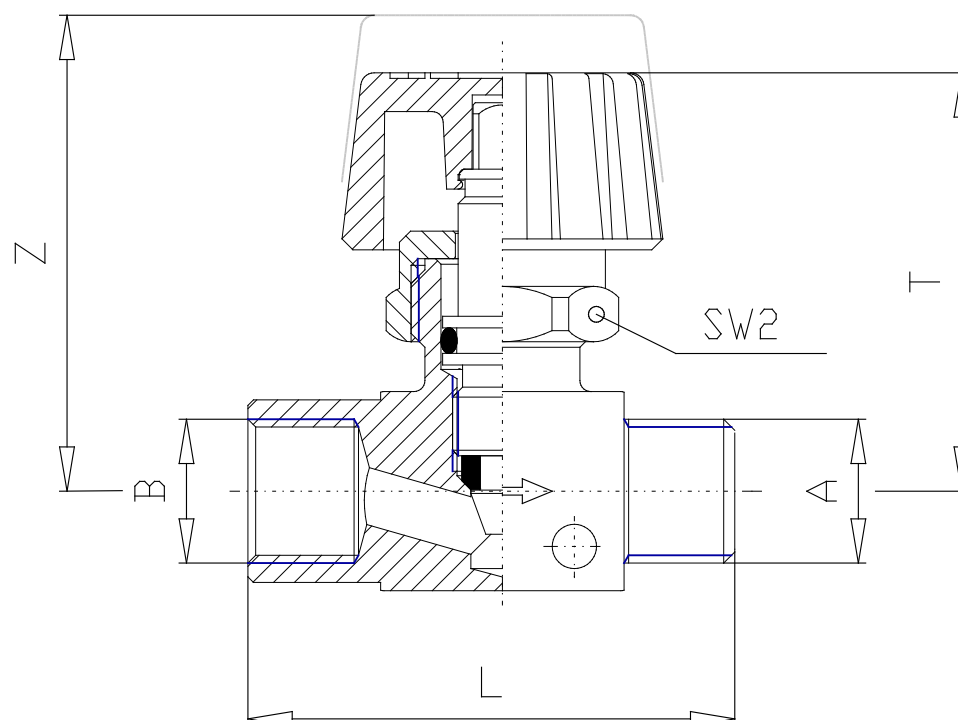

### DIMENSIONS

<b>A</b>	G3/8
<b>P</b>	-
<b>S</b>	-
<b>T (mm)</b>	41.5
<b>Z (mm)</b>	48.0
<b>SMAX</b>	-
<b>SW2</b>	22
<b>SW3</b>	-