

Valves - Series 28

Product code: 2820 1/2

Datasheet creation date: 19/05/2026 17:13

Check the most updated document online [click here](#)



TECHNICAL DATA

Mod.	2820 1/2
------	----------

Valves - Series 28

Product code: 2820 1/2

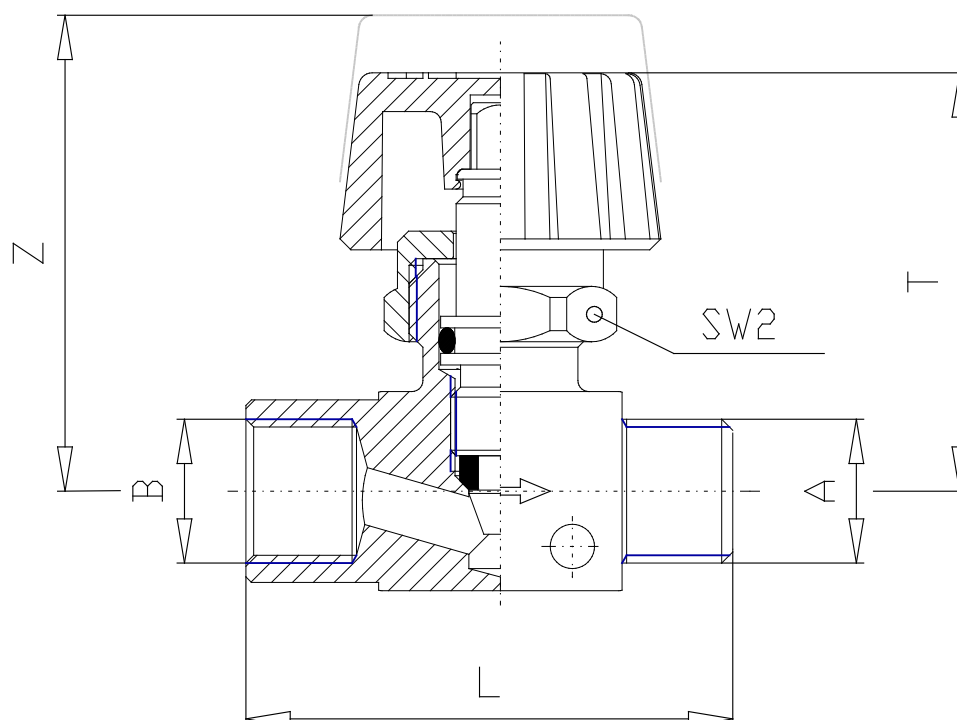

DIMENSIONS

A	G1/2
P	-
S	-
T (mm)	42.0
Z (mm)	49.0
SMAX	-
SW2	22
SW3	-