

Valves - Series 28

Product code: 2810 1/4

Datasheet creation date: 19/05/2026 17:14

Check the most updated document online [click here](#)



TECHNICAL DATA

Mod.	2810 1/4
------	----------

Valves - Series 28

Product code: 2810 1/4

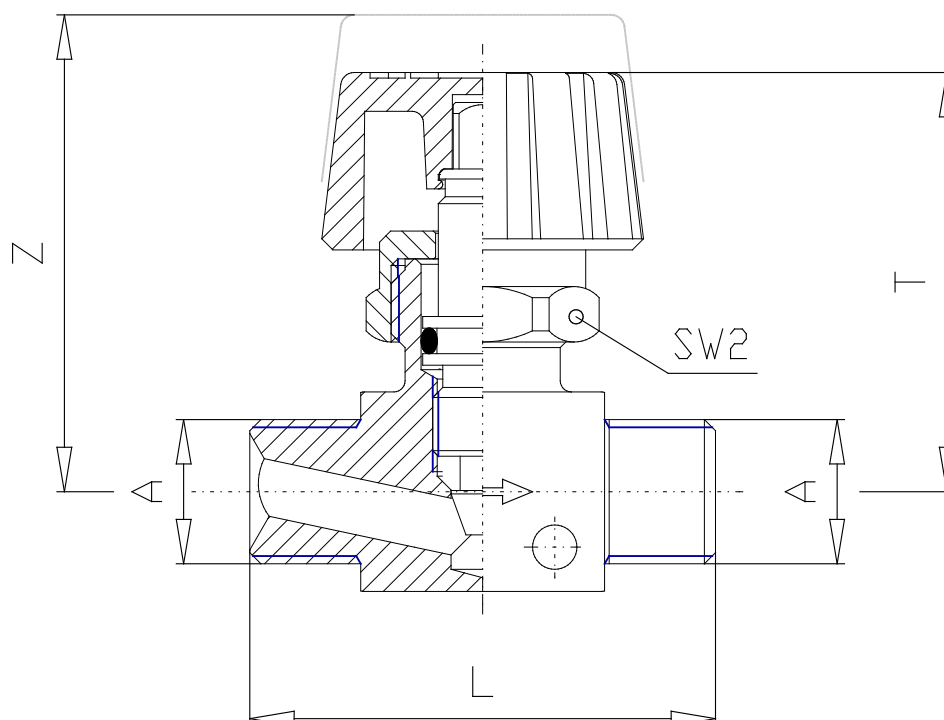

DIMENSIONS

A	G1/4
P	-
S	-
T (mm)	37.0
Z (mm)	42.5
SMAX	-
SW2	19
SW3	-