

## Round cylinders - Series 27

Product code: 27M2A32A0320

Datasheet creation date: 19/05/2026 20:11

Check the most updated document online [click here](#)



### TECHNICAL DATA

<b>Series</b>	27
<b>Diameter (mm)</b>	32
<b>Version</b>	M = rear end block with trunnion
<b>Operation</b>	2 = double - acting
<b>Materials</b>	A = rolled stainless steel
<b>Construction</b>	A = standard
<b>Stroke (mm)</b>	320
<b>Seal options</b>	= standard
<b>Rod length (mm)</b>	0
<b>Certifications</b>	= standard

## Round cylinders - Series 27

Product code: 27M2A32A0320

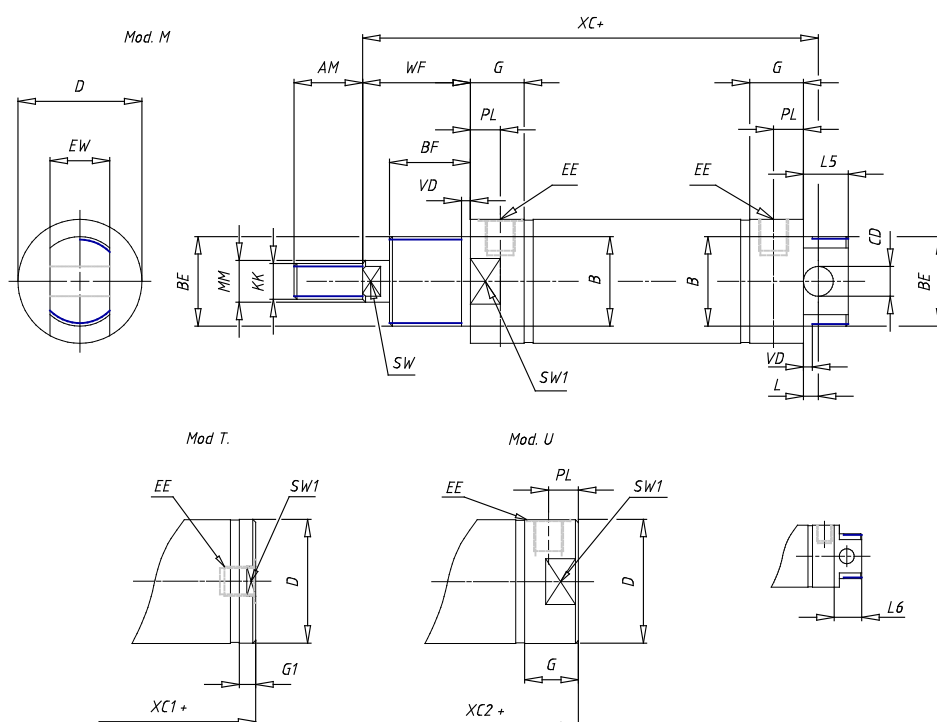

### DIMENSIONS

AM (mm)	22
Ø B (mm)	22
BF (mm)	15
BE	M22x1.5
Ø CD (mm)	8
Ø D (mm)	33.5
EE	G1/8
EW (mm)	16
G (mm)	17.5
G1 (mm)	5.5
KK	M10x1.25
L (mm)	7
Ø MM (mm)	12
L5 (mm)	15
L6 (mm)	20
PL (mm)	9
SW (mm)	10
VD (mm)	3
WF (mm)	23.0
XC (mm)	93.0
XC1 (mm)	74.0
XC2 (mm)	86.0
SW1 (mm)	30

BG (mm)	0
BG1 (mm)	0.0
FB	0
RT	0
Ø RT1 (mm)	0
TC (mm)	0
TF (mm)	0.0